

Wireless Weekly

Vol. 5.
No. 16

CONTENTS

Facts About Aerial Condensers.

A Three-Valve Loud-Speaker Set.

Transmitting Inductances.

ST73 on the Omni Receiver.

Untuned Aerials and Neutral-Grid Circuits.

A Home-made Aerial Mast.

Jottings by the Way, Random Technicalities, Valve Notes, An Efficient and Easily Made Tuning Coil, Starting Awkward Screws, Apparatus We Have Tested, Correspondence, Information Department, etc., etc.,

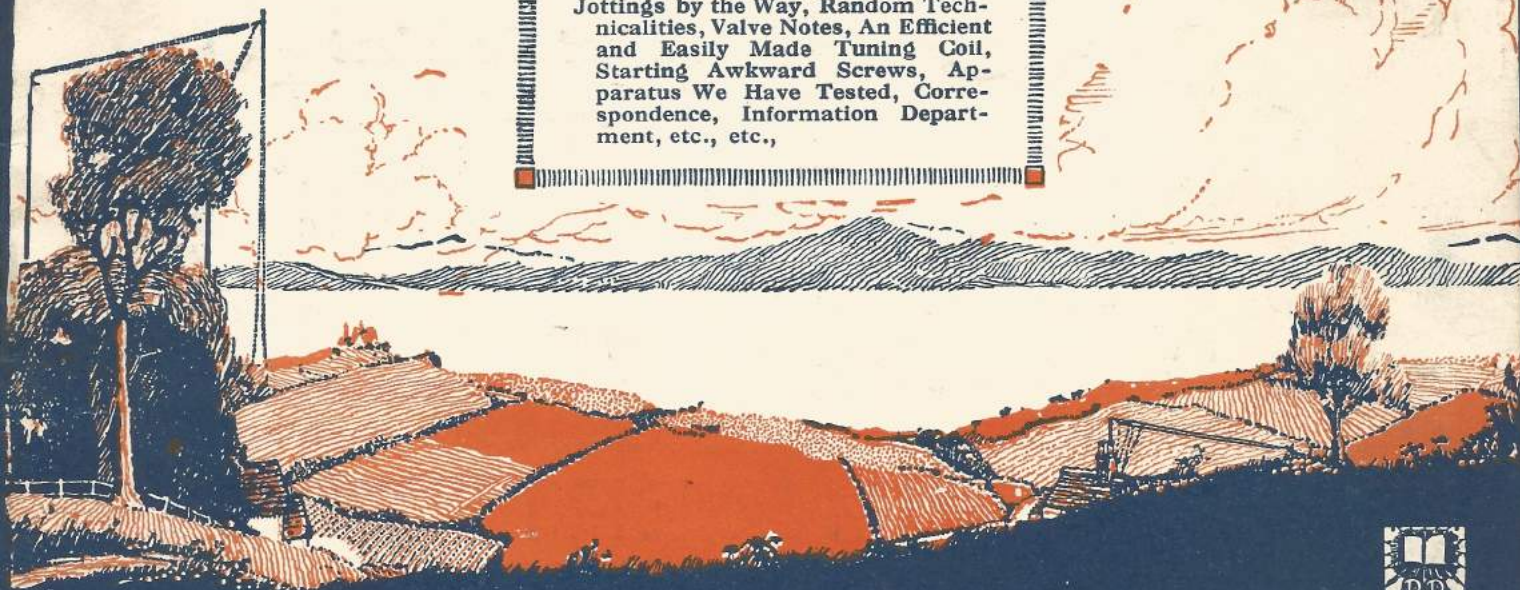

Continental Broadcasting Up-to-date

(COPYRIGHT)

The Burndept Crystal Detector

Reduced in Price

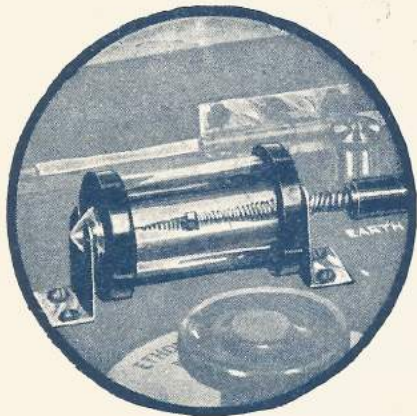

This illustration shows the Burndept Crystal Detector mounted on the panel of the Ethophone Junior Crystal Receiver. Without the use of tools, the Detector can be assembled right or left handed as desired.

No. 215.—Crystal Detector, for panel mounting, in carton, with screws and drilling template, **4s.**

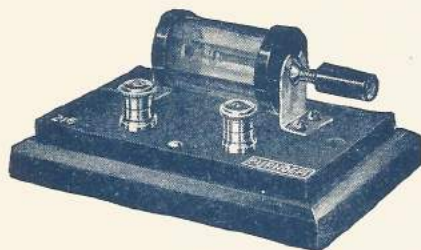

No. 216.—Crystal Detector, for experimental use, mounted on ebonite, **11s. 6d.**

BRANCHES :

LEEDS:
12, Basinghall Street,
(near City Square).
CARDIFF:
67, Queen Street.
NORTHAMPTON:
10, The Drapery.

BURNDEPT

WIRELESS APPARATUS

THE popular Burndept Crystal Detector, a component frequently recommended by Radio Press writers, has just been reduced in price by one shilling. A great demand has enabled us to save on production costs, the benefit being passed on to the public.

The Burndept Crystal Detector gives you crystal rectification in its most reliable and efficient form. The cat-whisker is controlled by a micrometer screw working through a ball-joint, and does not require frequent attention, remaining firmly in position when set. Delicate adjustments can be made easily. All moving parts and the sensitive synthetic crystal are enclosed in a glass tube.

The price reduction of one shilling applies to the experimental model, in which the Detector is mounted on an engraved ebonite panel fitted with gold-lacquered terminals, the whole being mounted on a polished walnut base.

Latest Burndept Catalogue sent FREE

Write for a copy of the 1925 edition of the Burndept Catalogue, which will be sent free and post free to any address in the United Kingdom. This 84-page Catalogue is fully illustrated and contains full particulars and prices of the whole range of Burndept wireless apparatus—components, accessories, complete receivers, receivers for home assembly and auxiliary apparatus. You will find it convenient to have a copy—send for one to-day. A catalogue of the new range of Burndept Transmitting Apparatus will also be sent on request.

BURNDEPT LTD.,
Aldine House, Bedford
St., Strand, London,
W.C.2

Telephone: Gerrard 9072.
Telegrams: "Burndept,
Westrand, London."

Purchase Burndept by its name—substitutes are not the same



Wireless Weekly

Radio Press, Ltd.
BUSH HOUSE, STRAND, W.C.2.
Tel.—City 9911.

Assistant Editor:
PERCY W. HARRIS,
M.I.R.E.

Scientific Adviser:
Prof. G. W. O. HOWE,
D.Sc., M.I.E.E.

Advisory Editors:
Prof. R. WHIDDINGTON,
M.A., D.Sc.

Prof. C. L. FORTESCUE,
M.A., M.I.E.E.

Staff Editors:
E. H. CHAPMAN,
M.A., D.Sc.

A. D. COWPER,
M.Sc.

R. W. HALLOWS,
M.A.

G. P. KENDALL,
B.Sc.

STANLEY G. RATTEE,
M.I.R.E.



EDITED BY JOHN SCOTT-TAGGART, F.Inst.P.,
A.M.I.E.E.

Vol. 5, No. 16

FEBRUARY 4, 1925

Price 6d. net.

The New Signalling Bill

WITHIN a short time the present Parliament will have placed before it a new Signalling Bill seeking to regulate the conduct of wireless telegraphy and telephony, and containing many sections of immense importance to the wireless amateur. Unless the Bill is carefully watched, and unless the experimenters of this country take concerted action, they may lose the few privileges they still have, and be saddled with restrictions which would effectively cripple the amateur movement for all time.

In spite of protestations to the contrary, it has been painfully evident for a long time that the Post Office would dearly love to place further restrictions on experimental wireless. On numerous occasions we have pointed out the anomalies of the present position, while the disconcerting way in which transmitting licences are granted to some people and withheld from others suggests that the many powers now possessed are very unintelligently administered. Again, we have the absurdity of a special permit being required to communicate with amateur stations outside this country.

In point of fact it is appreciated that some of the restrictions the Post Office now enforces are illegal, and we shall see clauses in the Bill seeking to regularise some of them. Particularly we shall have to guard against the insertion of clauses on the plea that there is no intention whatever of exercising the powers thus conferred, and that they are inserted merely as a formality.

Such specious arguments should

be immediately rejected. Even if permission to experiment under such clauses were readily granted (a very doubtful point) the conferring of far-reaching powers upon the Post Office in such circumstances is pernicious. The wireless experimenter is a valuable member of the community. Only those who have been

success had been obtained, the "experts" pointed out that even if the distance were traversed in this way it would be in the nature of a "freak," and that enormous powers were necessary for regular communication. Yet the success of the transatlantic experiments was far greater than even the most optimistic had hoped.

Continuing their short-wave experimental work, amateurs sought fresh fields to conquer, and, within the last twelve months have succeeded in effecting two-way communication with both New Zealand and Australia. As a result, Governments and commercial companies, no longer adopting the "superior" attitude, have taken to the short waves themselves for long-distance communication, and proudly announced to the world that it has been found possible to affect immense saving in power by use of the "new method."

The Radio Society of Great Britain, as the leading organisation of amateurs in this country, will, of course, give its attention to the new Bill, and we hope that all societies throughout the country, and all individual members, will give their hearty support to the Society at this time. Amateurs must insist upon their right to conduct experiments. With reasonable restrictions upon their activities they must be free to develop the art in their own way, and they must not tolerate any move which will make permission to conduct legitimate experimental work a favour and not a right.

CONTENTS	
	Page
Facts About Aerial Tuning Condensers	574
Jottings By The Way	576
Another Circuit on the Omni Receiver	578
Random Technicalities	580
Regular Programmes from Continental Broadcasting Stations	582
Valve Notes	586
Making a Start in Transmission	589
A Semi-Aperiodic Aerial Coupling for "Neutral-grid" Circuits	592
A Home-made Aerial Mast	594
A Three-Valve Loud-Speaker Set for the Local Station	596
Radio Notes and News	601
Marking and Drilling Ebonite Panels	602
Correspondence	603
Apparatus we Have Tested	605
Information Department	609

associated with wireless for a number of years know of the immense amount of pioneer work done by such men. We have not forgotten the superior attitude adopted in some quarters when a few years ago the first attempts were made by amateurs to communicate with one another on short wavelengths across the Atlantic. Before any

Facts about Aerial Tuning Condensers

By G. P. KENDALL, B.Sc., Staff Editor.

In the following article Mr. Kendall gives some interesting facts concerning the problem of series or parallel condenser.

IN many cases it is possible to obtain better signal strength upon the shorter wavelengths, such as those employed by the B.B.C., by connecting the aerial tuning condenser in series, provided that a direct earth is used, for the obvious reason that when the condenser is connected in this position it is possible to use a larger coil, across which greater differences of potential are set up, which can be applied to the valve or crystal. The reader will, no doubt, be aware that the size of the series capacity must lie within certain limits to give the best results, but I do not think many will have realised how extremely important a factor this is in determining the signal strength to be obtained with any particular coil. Certainly, the results of a recent simple series of experiments which I have carried out were a great surprise to me, although I was well aware, as most of us are, that if the series condenser was too small the amount of energy which could get through it to produce a difference of potential across the coil must be likewise small, while if it was too large the signals would also be poor, since the size of the coil which could be employed would be little larger than in the case of a parallel condenser.

The Experiment

The experiment is a very simple one, depending upon the method of signal strength measurement which I have described in recent articles, and it is one which I should advise everyone who possesses the necessary milliammeter to carry out, since I do not think that the result which I obtained should be regarded as of universal applicability. No doubt, with different aerial and earth conditions, the results obtained will differ slightly. The point which I wish to emphasize is that the actual size of the

aerial condenser is of extreme importance, when it is used in the series position, and that even where the experimenter is not in a position to carry out the measurements which I shall describe, he should yet make for himself a rule with regard to the minimum capacity which he should

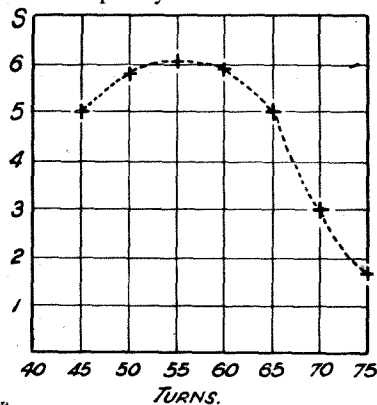

Fig. 1.—Showing the effect of turns variation using series condenser.

use under any conditions, since it seems worse to use too small a series capacity than one too large. I believe it is here that so many of us go wrong in the use of the series condenser, since it is a great temptation to use always as large a coil as possible, regardless of the inevitable reduction in the capacity of the series condenser, and it seems probable that this is one of the reasons why a certain number of experimenters say that the series position does not give such good results as the parallel.

The Method

The method of carrying out the experiment was as follows:—A basket coil was used wound with No. 24 d.c.c. wire upon a thin slotted cardboard former, no varnish or wax impregnation being employed. Seventy-five turns were put upon this coil, and the signal strength was then measured, and the reading of the aerial tuning recorded. It should be noted

that this condenser was of .00075 μ F capacity, and was of the square law type. This must be borne in mind in interpreting the dial readings. The dial, also, was of the 180 deg. type.

Signal Strength

The next step was to strip off five turns, and then to record the signal strength and condenser readings, after which a further five turns were removed, and so on, the signal strength given by a fixed standard coil being measured between each determination with the basket coil, to ensure that no variation in signal strength was taking place as a result of the proceedings of neighbours, and so on. Readings were taken every five turns until the coil was reduced to 45 turns, beyond which it was found impossible to go, because it was no longer possible to tune in the carrier wave of 2LO. A curve was then plotted, signal strength being recorded vertically and the turns upon the coil horizontally. The result is given in Fig. 1.

Results

It will be noted that the maximum signal strength was obtained with the 55-turn coil, the figure given being something like twice that obtained with the more conventional size of coil of perhaps 70 or 75. The curve appeared to be more or less symmetrical about the 55-turn point, but since signal strength does not have space to go far upon the left-hand side of this point, as a result of making the coil too small, there is little risk of going wrong here. On the other hand, it is quite easy to choose too large a coil, and it seems desirable to make some definite rule for oneself as to the actual reading of the aerial condenser dial, below which one will not go. In my own case it seems that this should be somewhere about the reading which is

given by the 55-turn coil, since beyond this point it will be seen that the curve falls rapidly to a much lower value than in the case of the 55-turn coil. This can be read from the table below. It will be seen that the equivalent dial reading to the 65-turn coil is 19 deg., and this, I believe, corresponds to a capacity of a little less than .0001 μ F in the case of this particular type of condenser.

Turns.	Signal Strength	A.T.C. reading.
75	1.6	4°
70	3	9°
65	5	19°
60	5.9	28°
55	6	42°
50	5.8	64°
45	5	104°

These figures, of course, apply to the wavelength of 365 metres, and I do not wish to convey the impression that they would hold for widely different wavelengths, and I have no doubt that a considerably different result would be obtained if the measurement was carried out upon, say, 100 metres. However, for the broadcast band I should regard this as being a useful guide, and have myself made it a rule never to reduce the capacity of the series condenser below the 20 deg. point upon the dial. It is a most useful guide, therefore, in choosing the size of coil for any broadcast station.

Series or Parallel

With regard to the actual figures obtained with the series

position of the condenser compared with the parallel, it may be of interest to give the figures obtained with my own aerial, which may be regarded as a typical one in which the series position is superior. Using coils wound upon the same system and the same gauge of wire, and in all respects as nearly identical as possible, except in regard to turn numbers, I find that with the series condenser the maximum signal strength obtained with the correct size of coil is in the neighbourhood of, say, 6, where with a parallel condenser it will be between 4 and 5. The results obtained, of course, will depend upon the type of coil you use for the determination.

The Standard

The standard which I used for comparison throughout the series of measurements was a commercial coil of a fairly efficient pattern, being, as a matter of fact, a specimen of the make which I have found superior to all other commercial varieties yet tested. This coil gave a signal strength of 5.3, with a reading of 54 deg. upon the aerial tuning condenser, indicating that it was of approximately the correct size for the reception of 2LO with my aerial. I mention this merely in order to show how the figures obtained are related to the values given by — commercial coils, since this coil can be fairly compared with the basket coil with the 50 turns, but I hope that readers will not write to me for the name of the coil in question!

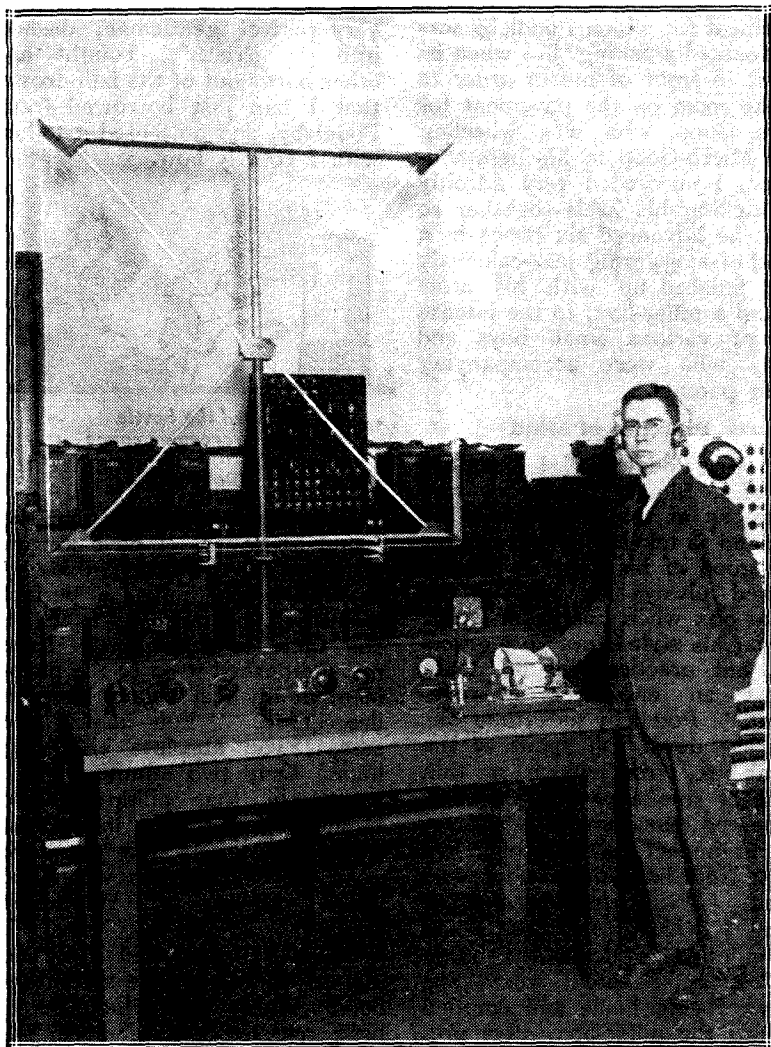

Mr. T. Parkinson, of the Bureau of Standards, Washington, D.C., preparing apparatus for radio observations during the eclipse of the sun. The special programme of radio observations in which the Bureau co-operated was initiated by G. W. Pickard, a noted Boston radio engineer.

Special Notice.

In order to enhance the attractiveness of the paper,

WIRELESS WEEKLY will in future appear in a **NEW and ARTISTIC COVER DESIGN.**

This will begin with the next issue,

Out on Feb. 11.



JOTTINGS BY THE WAY By Wireless Wayfarer

Sound Advice

"PODDLEBY," I said, as we were walking back from the club the other morning, "Poddleby, my friend, I don't know whether you realise the fact that if your girth continues to increase at its present rate we shall be very shortly called upon either to enlarge the club house door or to erect a special hut for the secretary outside it. It would be a terrible thing if you, who are the life and soul of the club, were unable, owing to sheer superfluity of adipose tissue, to attend our



... finished up with his arms round a pillar box . . .

meetings. You might, of course, stand on a stool outside, and put your head in through the window, but we should find it a little draughty, and you would, no doubt, grow weary of remaining upon your feet. A tennis umpire's chair—you know, one of those things like a step-ladder with a seat at the top of it—might possibly do, and we might even connect you wirelessly to the interior of the building so that you could hear our words of wisdom, and add your own to them whilst sitting on your little perch." Poddleby, I am sorry to say, did not take my remarks at all nicely; fat men never do when you tell them the truth. When I urged him to lead a more active life he retaliated by saying that I was the last person in the world to offer counsel of that kind. He even went on to say that if my figure was beyond reproach, I was un-

doubtedly fat-headed; in fact, if my head got much fatter I should before long require an outside in head telephones. As we were at the time in the High Street of Little Puddleton where all the *élite* of the town were taking their morning stroll, it was obviously impossible for me to administer the physical chastisement for which Poddleby was undoubtedly asking, but when he went in front of me in order to make room on the pavement for Mrs. Goop, who was wheeling the Micro-Goop in his perambulator, I succeeded very adroitly in kicking his heels together so that he advanced six paces in a kind of staggering jazz-cakewalk and finished up with his arms round a pillar-box, to the intense joy of various small boys and girls who were accompanying their parents.

Presence of Mind

"Mr. Poddleby," I explained to Mrs. Blood Thunderby, who came up at that moment, "has decided to take more exercise for the good of his figure. He has vowed always to run to the pillar-box when posting a letter. So far his style is not very graceful, but practice will no doubt effect an enormous improvement." Poddleby meantime was peering down the spout of the pillar-box, from which a thin trail of smoke was issuing. It appeared that such was the force of his impact that his pipe had leapt from his mouth and posted itself. With great presence of mind I seized from Mrs. Blood Thunderby's reticule the bottle of Worcester sauce which she was carrying home and emptied it into the pillar-box, thus preventing in the nick of time what might have been a most serious conflagration. We then summoned Scrabbits, our old postman, to release Poddleby's pipe.

Speechless

Mrs. Blood Thunderby had watched the scene without uttering a word. I could see by the way in which her face was working that she desired to say something, but could not find her voice. Thinking that the loss of her Worcester sauce might be preying upon her mind, I, being a very perfect gentleman, dashed into the grocer's, bought another bottle out of the half-crown that I had just borrowed from Poddleby, and presented it to her with a courtly bow.

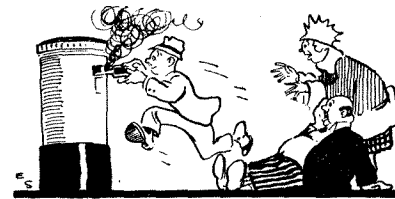

... I seized the bottle of Worcester sauce . . .

Told Off

It was at that moment that she found her voice. I have always regarded Mrs. Blood Thunderby as, above all things, a perfect memsahib, but the way in which she snatched that bottle from me and dashed it on to the pavement at my feet simply beggars description. "You idiot," she said, "you absolute blithering idiot. Only two minutes ago I posted in that pillar-box one hundred and fifteen invitations to my dance, and now you have gone and soused the whole lot with gallons of Worcester sauce." I did my best. I apologised; I grovelled; I bit the dust; I offered to take the letters home when Scrabbits should have released them, and to replace each in a clean, fair envelope. It was no good, no good at all. I simply received the glassiest of glares. And matters were made far worse when

Scrabbits arrived. He explained that whatever had passed through the gaping jaws of a pillar-box became automatically the property of the Postmaster-General until delivered. Poddleby, he said, could have his pipe by sending in a claim for it on the proper form and paying the postage due on an unstamped article. Mrs. Blood Thunderby's letters would have to be delivered in the ordinary way. Meantime P.C. Bottlesworth, who had strolled up, took Poddleby's name with a view to bring the charge against him of endeavouring to set fire to the contents of a pillar-box, and mine for introducing obnoxious liquids into the same place.

The Irony of Fate

As General Blood Thunderby is chairman of the local Bench, I rather fancy that both my stout friend and myself will be for it in the course of the next two or three days. Such is the reward meted out to a man who does the right thing at the right moment. A land fit for heroes to live in? Yes. It takes a hero to live in it. You have heard of the irony of fate, have you not? My invitation was duly delivered the next morning. It was the only one which had not been faithfully dealt with by the Worcester sauce. I have declined it gracefully on the grounds that the doctor has ordered me a long and complete rest.

The Regime

But to return to Poddleby. He came round to see me on the following Monday, and, after beating about the bush for some time, asked if I was really serious when I said that he was expanding. I replied that I was, and that if he wanted to know the specific for reducing weight I could tell him. It was Worcester sauce, for I had tried it, and it had caused me to lose at least two stone in the last twenty-four hours. He said that he wished to talk seriously, and noticing that the time was 12.45 p.m. I pressed him to stay for lunch. He did. It was Monday. The *pièce de résistance* was cold beef—and Worcester sauce. When they had undone my collar, dashed water in my face, and flapped towels at me for a few minutes I came round

again. After that ghastly meal Poddleby and I sat down for a little heart-to-heart talk. It is quite obvious that a wireless man can take little exercise if he is to do his job properly. It is therefore quite out of the question to prescribe long walks for Poddleby or anything of that kind. I suggested, therefore,



. . . P.C. Bottlesworth took Poddleby's name . . .

that he should forthwith sell all his dull-emitter valves, replacing them with the brightest of the bright.

A Promise

This means that he will have to carry his 100-ampere hour accumulator round to the garage, which is two miles away from his house, at least once a week. To make quite sure that he duly consumed the necessary amount of juice, I made him promise that he would sit up for America every night until three o'clock in the morning, and that he would in future arise with the lark, as I do. Luckily the local larks have no fondness for worms, and are therefore not disgustingly early birds—have you ever reflected that if the early bird gets the worm it is the early worm that is for it? It was further resolved that Poddleby should hand over to me his exist-



. . . He will have to carry his 100-ampere hour accumulator . . .

ing collection of highly-priced grid-leaks and transformers, and that I should give him in their stead specimens from my museum, which contains the world's worst in these lines.

Poddleby's Fate

Nothing, I think, is so calculated to thin a man down as the manipulation

of a receiving set which, despite all efforts, endows every speaker or singer with adenoids, nasal catarrh, and tone deafness, whilst it makes an orchestra play completely out of tune on certain notes, and punctuates the whole performance with cracklings, fizzes, bangs, splutterings, scrapings and occasional howls. This is what is going to happen to the man Poddleby, and I think that I can guarantee that if he rigorously follows the course which I have prescribed he will shortly be able to see his boots once more.

Gratitude

Of course, you never know with these fat men. That is the trouble. They will come rushing round to you for advice, to which they listen with tears coursing down their bloated cheeks. They will wring your hand in gratitude, they will tell you that you are the best fellow in the world, and that they can never sufficiently repay your kindness. They can, of course, quite easily, but it is no use expecting them to make the attempt. A brace of pheasants, I mean, or a case of champagne, or even a cheque would answer very well, but these things never materialise. No, they drink in all your wise words, they promise to follow your advice, and then they simply do nothing at all. However, now that I have taken Poddleby in hand, I intend to go through with the matter. I may tell you in confidence that one of my first actions after Poddleby had left was to interview his tailor. I know to the fraction of an inch what his last lower chest measurement was, and I am going to take him round to order a new waistcoat, and to see him measured for it every week till he gets well within the forties. Further, I am a great believer in a little worry as a thinning agent. I intend to steal round at nights to Poddleby's garden and do all kinds of fat-dissolving things. I shall snip his earth-lead; I shall short-circuit his aerial insulators; I shall sever most of the strands of his aerial lead-in—in fact, I shall generally play havoc to poor Poddleby's reception until he has dropped the odd stone or two that are now embarrassing him.

WIRELESS WAYFARER.

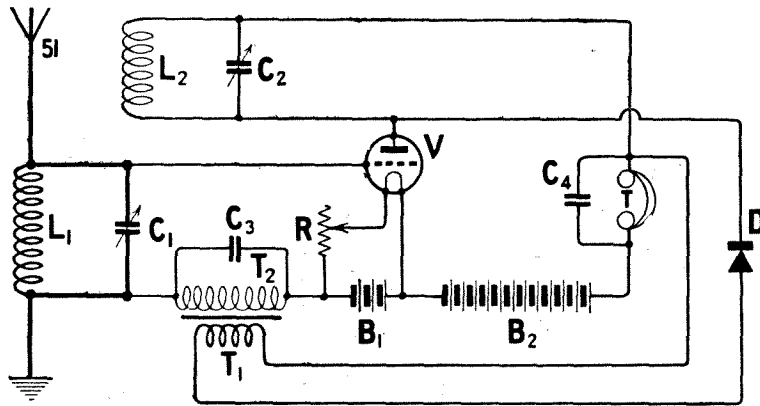

Fig. 1.— The ST73 circuit.

Another Circuit on the Omni Receiver

ALTHOUGH it has often been emphasised that the best all-round single-valve circuit for general use is that in which the valve is used as a detector, reaction being coupled to the aerial circuit, a large number of experimenters prefer the single-valve circuit given in Fig. 1 for volume and also for purity of reception, the latter being due to the fact that a crystal is employed for detection.

The Working of the Circuit

The aerial is tuned by the coil L_1 and variable condenser C_1 of .0005 μF maximum capacity, the incoming high-frequency oscillations being applied to the grid of the valve V . The resultant H.F. pulses appear in the anode circuit of the valve which is tuned by the coil L_2 and variable condenser C_2 of .0005 μF . Across this coil are connected the crystal detector D and the primary winding T_1 of the low-frequency transformer $T_1 T_2$. Detection is carried out by the crystal detector, the low-frequency impulses in T_1 being transferred to the secondary winding T_2 and applied to the grid of the valve, which consequently amplifies at low as well as high-frequency. The low-frequency currents in the anode circuit cause the telephones to respond. The fixed condensers C_3 and C_4 have values of .0003 and .002 μF respectively.

It will be seen from the foregoing that using one valve and a crystal detector, high-frequency amplification, followed by detec-

tion, and a stage of low-frequency amplification is obtained.

Connections

Suitable connections for wiring the circuit on the Omni receiver are as follows:—

51—17	32—40
25—52	39—23
17—18	47—31
25—26	4—28
17—12	20—21
4—41	22—23
41—42	29—48
33—34	30—52
33—23	19—30
31—24	27—29

Coil Sizes

If it is desired to receive one of the broadcasting stations

working within the usual wavelength band, a No. 25, 35, or 50 coil will be required in the aerial socket, which in the present case is the fixed centre socket of the three-coil holder on the left-hand side of the cabinet. The socket for the anode coil is the front moving socket of the same coil holder, and for the wavelength range mentioned, a No. 50 or No. 75 coil will be suitable.

For the reception of Chelmsford, a No. 150 coil should be plugged into the aerial socket and a No. 250 in the anode socket.

Operation of the Receiver

With the various accessories connected to their respective

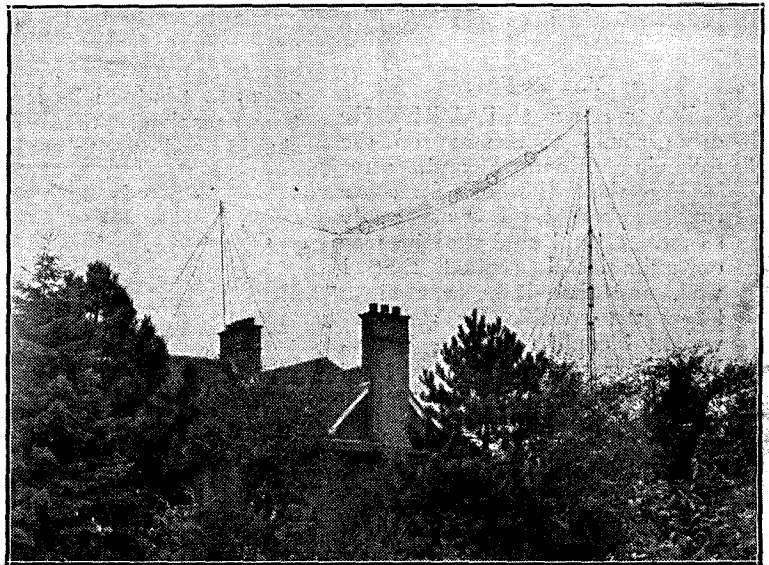

The aerial at 2NM, the station belonging to Mr. Gerald Marcuse, who will represent British Amateurs at the International Convention next spring.

* * *

An interesting Single-valve Reflex Circuit which may be compared with the ST74 Circuit

* * *

terminals on the set, the operation of tuning may be carried out. To commence with, the two coils should be placed as far apart as the coil holder permits, and the aerial and anode tuning condensers varied until the desired station is received at maximum strength. The crystal detector will, of course, need careful adjustment for best results.

The effect of bringing the anode coil towards the aerial coil may now be tried, with further variations of the two tuning condensers. If louder signals do not result it is possible that a reversal of the leads to the anode coil will produce better results. The reversal is obtained by disconnecting the leads 4-41 and 33-23, and joining 4-33 and 41-23. Bringing the coils closer together may result only in oscil-

lation, so that best results may quite possibly be obtained when they are arranged at right angles to each other.

Constant Aerial Tuning

Where experimenting with different sizes of aerial coils on the lower wavelengths is viewed with distaste, constant aerial tuning should be employed. This is brought into use by disconnecting the lead 51-17 and joining 51-11 and 3-17. It is now possible to state definitely that for the broadcast wavelengths below 420 metres a No. 50 coil will be suitable in the aerial socket, while for the wavelengths above 420 metres a No. 75 coil should be used.

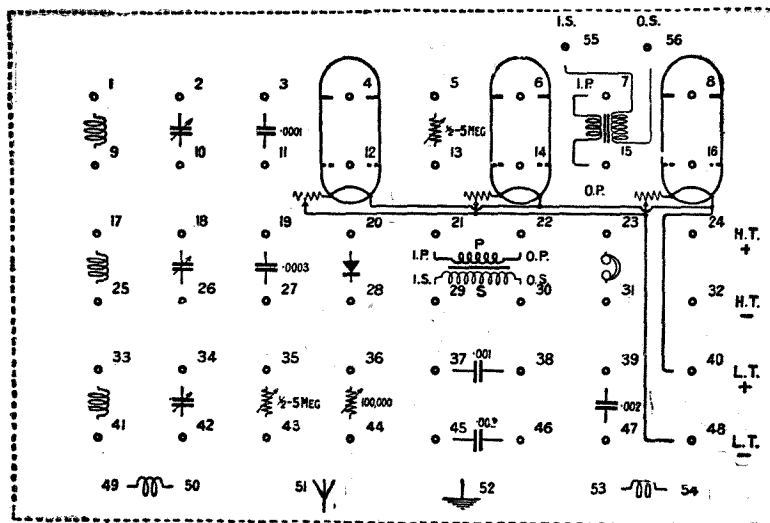

Fig. 2.—The terminal board.

If Howling Occurs

The circuit is rather prone to howl under certain conditions, and should this occur, the following experiments (which may be tried with beneficial results in any case) should cure the trouble. A circuit similar to this, but improved considerably in so far as stability is concerned, was described for use on the Omni receiver in the issue of *Wireless Weekly* for March 5, 1924, and it is interesting to compare the two circuits and note their respective merits.

Variation of the values of the two fixed condensers C3 and C4 may make a noticeable difference to the volume of sound obtained, and C3 might be replaced by the unused variable condenser 2, 10, for experimental purposes.

An important experiment is to try reversing the leads to the secondary and primary windings of the L.F. transformer—especially the former. It is unlikely that howling will persist throughout these experiments, but if so, a variable resistance should be connected between the grid and positive side of filament of the valve. This resistance is controlled by the centre knob of the three resistance knobs on the front of the panel, and in order to connect it in circuit, the connections 36-12 and 40-44 should be made. The value of the resistance should be maintained as high as is consistent with stability.

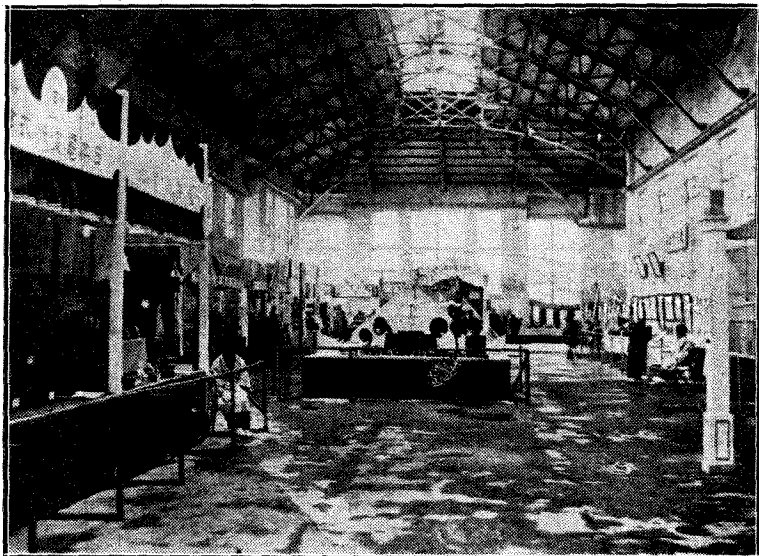

The interior of the second Radio Exhibition which was recently held in Tokio.

Random Technicalities

By *PERCY W. HARRIS, M.I.R.E., Assistant Editor.*

Some Notes of general interest to the Home Constructor and Experimenter.

AFTER a long series of failures there are signs of success in the solution of the problem of "permanent" crystal detectors. Although, after some practice, the adjustment of the cat-whisker type of detector is by no means difficult, and one comes to learn instinctively just how much pressure to apply and how, the fact remains that many people seem temperamentally incapable of adjusting any type of cat-whisker detector. I am well aware that in the past many devices have been claimed to be permanent in their adjustment, but the great majority of these have fallen down dismally on test. Being of an inquiring turn of mind I have frequently cut open the carefully sealed cases of such detectors, and in many cases have found that they consisted merely of a cat-whisker stuck to some portion of the crystal surface by a piece of sealing wax or a dab of plasticine. If the original adjustment happens to be good, the detector remains satisfactory for some time, but once the sensitivity of the point is lost through a strong atmospheric or some other violent electrical disturbance, the detector gives up the ghost.

Other sealed detectors claiming to be permanent have sometimes consisted of a zincite and bornite crystal held in contact and sealed in place. Here again the value of the device depends upon the sensitivity of the original contact and just how long a time will elapse before a jolt spoils the sensitivity.

The carborundum detector has many points in its favour, for the crystalline substance is intensely hard, and quite a strong pressure upon it may be exerted without injuring the sensitivity of the point. Unless used with very

strong signals, a carborundum detector requires the application of additional potential by means of a potentiometer and one or two dry cells.

* * *

The problem of adjustment of crystal detectors, or rather the simplicity of operation, has been tackled from another point of view in such detectors as the

"Gravity" (to which I have previously referred in these notes) and the Harlie, in which a cat-whisker bears against a small cylinder of special material. Both of these detectors deserve to be classed as "fool-proof" and are very suitable for use by old people, whose hands are not steady enough to adjust the ordinary rather delicate cat-whisker type of detector.

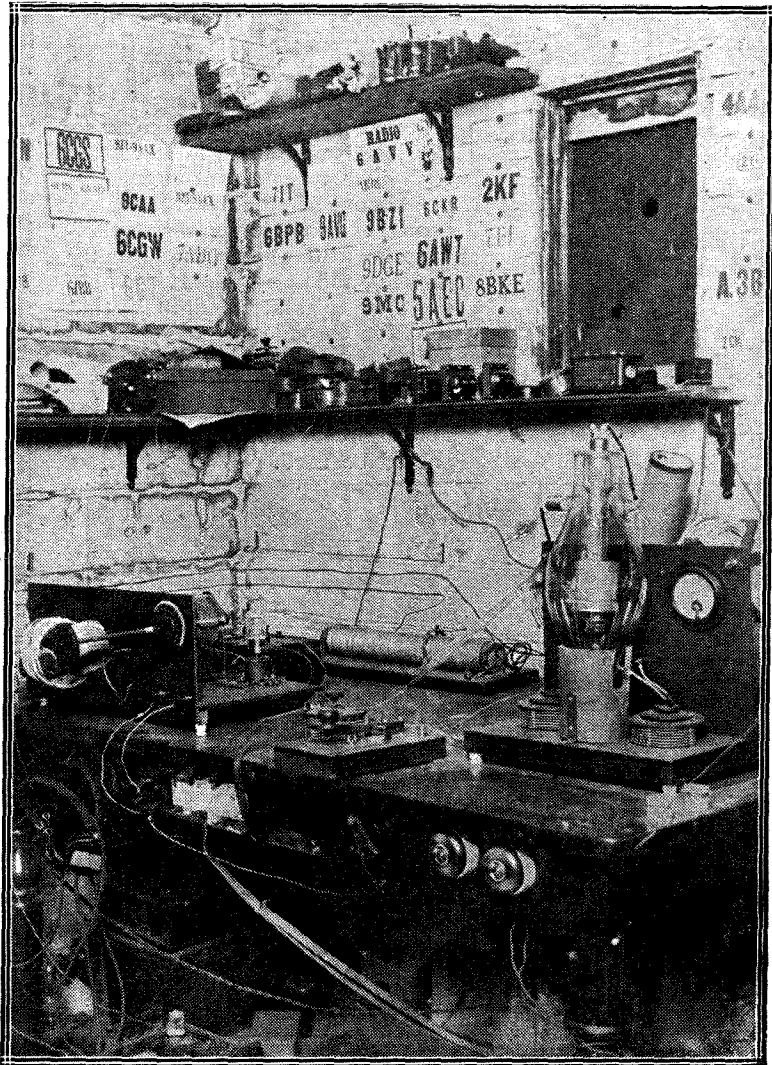

Our photograph shows Australian 3BQ, with which station Mr. W. K. Alford (2DX) is able to establish communication.

I fancy that manufacturers of crystal sets do not take sufficiently into account the fact that a very large number of crystal sets are sold for people who are no longer in the prime of life, and who like to sit by the fireside and enjoy the broadcasting programmes. Very many of these people have failing sight and trembling fingers. A good, substantial and yet sensitive crystal receiver specially designed for such people should have a ready sale. I would suggest as essentials in such sets special large tuning dials with the degrees much more clearly marked than is usually the case, a substantial knob and heavy terminals, to which the attachment of wire is a very simple business. Many commercial crystal sets have "fiddling" terminals which require a good light, good sight, and some patience for the attachment of wires. The set should be sent out with telephones already fitted with those delightfully soft cushion earpieces made of spongy rubber. The telephone bands supplied should also be of the type which do not grip the hair and tear it out in tufts whenever the 'phones are removed. Finally, the set should be made up in a cabinet of generous proportions and heavy base, which will not be slipped off the table by a slight jerk of the telephone cords, as so frequently happens.

* * *

May I make another suggestion to manufacturers of complete sets? One of the difficulties in the use of the .06 type of valve is that filament resistances can be altered to give adequate current to the valve long after the accumulator, if one is used, has been discharged much below the safe point. Whenever a commercial set is sent out with a .06 type of valve and a four-volt accumulator, some kind of stop should be fitted to the filament resistance to prevent the movement of the arm any further than the point of adjustment for efficient working when the voltage of the accumulator has not dropped below a safe figure. As it is, the set can be used right up to a point when the accumulator has discharged below 1.5 volts — which is thoroughly bad practice and injurious to the cells.

Some Readers' Letters

SELECTIVITY

SIR,—We have read with considerable interest "Valve Notes" in the January 14 issue of *Wireless Weekly*, which touches upon a new method of coupling valves for high-frequency amplification, and as the Unitune aperiodic fixed coupler manufactured by this company is wound on the principle outlined in your article, we were constrained to try this instrument in the combination suggested by you, and so far the results appear to be extremely promising.

There is, however, a marked reduction of signal strength noticeable, although the selectivity was undoubtedly improved, and we are wondering whether the tests which you indicate were carried out in close proximity to London broadcasting station. If this be the case, it appears to us that a reduction in signal strength would not be so noticeable as it is here in Bedford, where we are 50 miles from the nearest broadcasting station, but we also tried the arrangement suggested by you, namely, to use two separate coils.

This arrangement also gave fairly satisfactory results, and the signal strength was considerably increased, but the increased selectivity was not quite so prominent.

There seems to be a wide need for really efficient methods of obtaining increased selectivity, and we are pursuing our experiments

on the lines suggested by you, and we shall be pleased in due course to write you more fully with our observations upon what we have been able to achieve.

At the same time, we are taking this opportunity of congratulating you upon the opportune leading article which appears in the same issue of your journal, and we endorse to the fullest extent your sentiments upon the need for the protection of the public against the cheap and shoddy material of unknown make which has been so prevalent, but which happily is fast dying a natural death.—Yours faithfully,

IGRANIC ELECTRIC CO., LTD.

A. H. CURTIS, General Manager.
Bedford.

ST100 WITH H.F.

SIR,—This is the second time I have written to you thanking you for a valuable circuit—ST100 + H.F. set described in *Modern Wireless* June issue. It really is wonderful where the volume comes from and where the "mush" goes. The results are all the more satisfactory in that we are using Peanut valves.

Thanks!—Yours faithfully,

W. DRAKE.

Huddersfield.



The stand of the *Compañia Nacional de Telegrafia sin Hilos*, an affiliated Marconi Company, at the Madrid Exhibition, which was held recently.

Regular Programmes from Continental Broadcasting Stations

Telephony except when otherwise stated. Corrected up to January 29th, 1925.

Edited by CAPTAIN L. F. PLUGGE, B.Sc., F.R.Ae.S., F.R.Met.S. Strictly Copyright.

WEEK DAYS.

Ref. No.	G. M. T.	Name of Station.	Call Sign and Wave-length.	Situation.	Nature of Transmission.	Closing Time or Approx. Duration.	Approx. Power used.
1	a.m.	Hamburg ...	— 395 m. ...	Germany ...	Time Signal in C.E.T. and Exch.	5 mins.	700 Watts.
2	6.25	Eiffel Tower	FL 2600 m.	Paris ...	Weather Forecast ...	5 mins.	5 Kw.
4	7.05	Lausanne ...	HB2 850 m.	Switzerland	Weather Report ...	5 mins.	300 Watts.
5	7.55	Persbureau Vaz Dias.	PCFF 2125 m.	Amsterdam	Stocks, Shares and News ...	10 mins.	2 Kw.
8	9.23	Eiffel Tower	FL 2600 m.	Paris ...	Time Signal in G.M.T. (Spark)	3 mins.	60 Kw.
9	9.55	Persbureau Vaz Dias.	PCFF 2125 m.	Amsterdam	Stocks, Shares, and News ...	10 mins.	2 Kw.
10	10.00	Eiffel Tower	FL 2600 m.	Paris ...	Time Signal in Greenwich Sidereal Time (Spark).	5 mins.	60 Kw.
156	10.00	Radio-Wien	— 530 m.	Austria ...	Concert ...	Noon	1 Kw.
180	10.15	Breslau ...	— 418 m.	Silesia ...	Weather Report—Exchange ...	10 mins.	1.5 Kw.
11	10.30	Lyons ...	YN 550 m. ...	Lyons ...	Gramophone Concert ...	30 mins.	300 Watts.
12	10.30	Kbel ...	— 1160 m.	Prague ...	Exchange quotations ...	10 mins.	1 Kw.
13	10.44	Eiffel Tower	FL 2600 m.	Paris ...	Time Signal in G.M.T. (Spark)	3 mins.	60 Kw.
14	10.55	Eiffel Tower	FL 2600 m.	Paris ...	Fish Market Quotations—Cotton Exchange.	10 mins.	5 Kw.
182	11.00	Leipzig ...	— 454 m.	Germany ...	Stock Exchange News followed by Concert.	12 (noon)	700 Watts.
184	11.00	Zurich ...	— 515 m.	Switzerland	Weather Report ...	5 mins.	500 Watts.
15	10.55	Frankfurt ...	— 470 m.	Frankfurt	Time Signals in C.E.T. (spoken) followed by News.	5 mins.	1 Kw.
17	11.10	Persbureau Vaz Dias.	PCFF 2125 m.	Amsterdam	Stocks and Shares ...	20 mins.	2 Kw.
18	11.14	Eiffel Tower	FL 2600 m.	Paris ...	Time Signal in Greenwich Time (Spoken) followed by Weather Forecast.	5 mins.	5 Kw.
20	11.15	Voxhaus ...	— 430 m.	Berlin ...	First News Bulletin and Weather Reports.	5 mins.	700 Watts.
30	11.30	Stockholm ...	— 430 m.	Sweden ...	Weather Forecast, followed by Exchange and Time Signal from Nauen.	Noon	750 Watts.
23	11.57	Nauen ...	POZ 3100 m.	Berlin ...	Time Signal in G.M.T. (Spark)	8 mins.	—
22	11.57	Leipzig ...	— 454 m.	Germany ...	Time Signal Relayed from Nauen	3 mins.	700 Watts.
185	11.57	Zurich ...	— 515 m.	Switzerland	Time Signal do.	3 mins.	500 Watts.
183	11.57	Munster ...	— 410 m.	Westphalia	Time Signal do.	3 mins.	1.5 Kw.
19	11.57	Konigsberg ...	— 463 m.	East Prussia	Time Signal do.	3 mins.	1 Kw.
21	11.57 noon	Voxhaus ...	— 430 m.	Berlin ...	Time Signal do.	3 mins.	700 Watts.
157	12.00	Zurich ...	— 515 m.	Switzerland	Weather Forecast, Shares News	5 mins.	500 Watts.
24	12.00	Persbureau Vaz Dias.	PCFF 2125 m.	Amsterdam	Stocks and Shares ...	8 mins.	2 Kw.
26	p.m.	Geneva ...	HB1 1100 m.	Switzerland	Lecture ...	12.45 p.m.	300 Watts.
25	12.30	Kbel ...	— 1160 m.	Prague ...	Exchange Quotations ...	10 mins.	1 Kw.
27	12.30	Lausanne ...	HB2 850 m.	Switzerland	Weather Reports, Time Signal in C.E.T. and News.	15 mins.	300 Watts.
32	12.30	Radio-Paris ...	SFR 1780 m.	Clichy ...	Concert followed by News ...	2 p.m.	8 Kw.
31	12.45	Persbureau Vaz Dias.	PCFF 2125 m.	Amsterdam	Stocks and Shares ...	10 mins.	2 Kw.
33	1.00	Haeren ...	BAV 1100 m.	Brussels ...	Weather Forecast in French and English.	8 mins.	150 Watts.
34	1.00	Munich ...	— 485 m.	Bavaria ...	News and Weather Report ...	10 mins.	1 Kw.
37	1.15	Voxhaus ...	— 430 m.	Berlin ...	Stock Exchange News ...	5 mins.	700 Watts.
35	1.15	Komarow ...	— 1800 m. ...	Czecho-Slovakia.	Stock Exchange and Late News	10 mins	1 Kw.

Ref. No.	G. M. T.	Name of Station.	Call Sign and Wave-length.	Situation.	Nature of Transmission.	Closing Time or Approx. Duration.	Approx. Power used.
WEEK DAYS (Contd.)							
181	p.m. 2.00	Breslau ...	— 418 m.	Silesia ...	Weather Report and Exchange Quotations.	10 mins.	1.5 Kw.
40	2.30	Munster ...	— 410 m.	Westphalia	Stocks, Shares and News ...	10 mins.	1.5 Kw.
38	2.40	Persbureau Vaz Dias	PCFF 2125 m.	Amsterdam	Stocks, Shares and News ...	10 mins.	2 Kw.
39	2.45	Eiffel Tower	FL 2600 m.	Paris ...	Exchange Opening Prices. (Sat. excepted).	8 mins.	5 Kw.
158	3.00	Zurich ...	— 515 m.	Switzerland	Hotel Baur au Lac Concert, Relayed. (Fri. excepted.)	5 p.m.	500 Watts.
202	3.00	Munster ...	— 410 m.	Westphalia	Concert	5 p.m.	1.5 Kw.
159	3.10	Radio-Wien ...	— 530 m.	Vienna ...	Concert	5 p.m.	1 Kw.
42	3.30	Frankfurt ...	— 470 m.	Germany ...	Light Orchestra	5 p.m.	1 Kw.
43	3.30	Konigsberg ...	— 463 m.	East Prussia	Light Orchestra (Wed. and Sat. Children's Hour).	1 hour	1 Kw.
44	3.30	Voxhaus ...	— 430 m.	Berlin ...	Concert, followed by News ...	5 p.m.	700 Watts.
46	3.30	Leipzig ...	— 454 m.	Germany ...	Concert	5 p.m.	700 Watts.
47	3.35	Eiffel Tower	FL 2600 m.	Paris ...	Exchange Quotations (Sat. excepted).	5 mins.	5 Kw.
48	3.55	Persbureau Vaz Dias.	PCFF 2125 m.	Amsterdam	Stock Exchange and News ...	10 mins.	2 Kw.
49	4.00	Kbel ...	— 1160 m.	Prague ...	Concert	5 p.m.	1 Kw.
160	4.00	Breslau ...	— 418 m.	Silesia ...	Light Orchestra	5 p.m.	1.5 Kw.
51	4.30	Radio-Paris ...	SFR 1780 m.	Clichy ...	Concert preceded and followed by News.	5.45 p.m.	8 Kw.
52	4.30	Eiffel Tower	FL 2600 m.	Paris ...	Exchange Closing Prices (except Saturday).	8 mins.	5 Kw.
53	4.45	Stuttgart ...	— 443 m.	Wurtemberg	Concert followed by Weather Report (Saturday excepted).	6 p.m.	1 Kw.
54	5.00	Radio-Belg. ...	SBR 265 m.	Brussels ...	Concert followed by News ...	6 p.m.	2.5 Kw.
186	5.00	Frankfurt ...	— 470 m.	Germany ...	Lecture	5.30 p.m.	1 Kw.
187	5.00	Hamburg ...	— 395 m.	Germany ...	Light Music	6.00 p.m.	700 Watts.
161	5.30	Munich ...	— 485 m.	Bavaria ...	Light Orchestra or Lecture ...	6.30 p.m.	1 Kw.
162	6.00	Eiffel Tower	FL 2600 m.	Paris ...	Concert followed by News Bulletin.	6.55 p.m.	5 Kw.
177	6.00	Radio-Barcelona	EAJ1 325 m.	Barcelona	Concert	7.00 p.m.	650 Watts.
57	6.30	Kbel ...	— 1160 m.	Prague ...	Concert and News	8 p.m.	1 Kw.
58	7.00	Eiffel Tower	FL 2600 m.	Paris ...	General Weather Forecast ...	8 mins.	5 Kw.
60	7.00	Radio-Wien ...	— 530 m.	Vienna ...	Concert	9 p.m.	1 Kw.
188	7.00	Frankfurt ...	— 470 m.	Germany ...	Lecture	7.30 p.m.	1 Kw.
61	7.00	Konigsberg ...	— 463 m.	East Prussia	Concert and News	9 p.m.	1 Kw.
62	7.00	Hamburg ...	— 395 m.	Germany ...	Concert and Late News ...	9 p.m.	700 Watts.
63	7.00	Stuttgart ...	— 443 m.	Wurtemberg	Concert and News (Wed. and Sat. till 10 p.m.)	9.15 p.m.	1 Kw.
66	7.15	Lausanne ...	HB2 850 m.	Switzerland	Concert (Monday excepted) ...	9.30 p.m.	300 Watts.
64	7.15	Zurich ...	— 515 m.	Switzerland	Concert followed by Late News	9 p.m.	500 Watts.
65	7.15	Leipzig ...	— 454 m.	Germany ...	Concert and News (Wed. and Sat. till 10.30 p.m.)	8.40 p.m.	700 Watts.
67	7.30	Frankfurt ...	— 470 m.	Germany ...	Concert and News	10 p.m.	1 Kw.
59	7.30	Munster ...	— 410 m.	Westphalia	Concert followed by News ...	9 p.m.	1.5 Kw.
72	7.30	Voxhaus ...	— 430 & 505 m.	Berlin ...	Concert followed by News and Weather Report.	9.30 p.m.	0.7 and 1.5 Kw.
73	7.30	Munich ...	— 485 m.	Bavaria ...	Concert and News	8.40 p.m.	1 Kw.
69	7.30	Breslau ...	— 418 m.	Silesia ...	Concert	9 p.m.	1.5 Kw.
164	7.30	Radiofonica Italiana.	— 425 m.	Rome ...	Concert followed by News (Interval between 8.20 and 8.30)	9.30 p.m.	4 Kw.
74	8.15	Radio-Belg. ...	SBR 265 m.	Brussels ...	Concert preceded and followed by News.	10.10 p.m.	2.5 Kw.
75	8.30	Ecole Sup. des P. & Tg.	FPTT 450 m.	Paris ...	Concert, sometimes preceded by Lecture, usually outside broadcast.	9 p.m.	500 Watts.
76	8.30	Radio-Paris ...	SFR 1780 m.	Clichy ...	Detailed News Bulletin... ..	9 p.m.	8 Kw.
77	9.00	Radio-Paris ...	SFR 1780 m.	Clichy ...	Time Signal followed by Concert	9.50 p.m.	8 Kw.
78	9.00	Radio-Iberica	RI 392 m.	Madrid ...	Concert, Advertisements ...	Midnight	3 Kw.
189	9.00	Radio-Barcelona	EAJ1 325 m.	Barcelona	Concert	11 p.m.	650 Watts.
190	9.00	Munster ...	— 410 m.	Westphalia	Lecture	9.45 p.m.	1.5 Kw.
79	10.00	Eiffel Tower	FL 2600 m.	Paris ...	Time Signal in Greenwich Sidereal Time (Spark).	5 mins.	60 Kw.
80	10.10	Eiffel Tower	FL 2600 m.	Paris ...	General Weather Forecast ...	5 mins.	5 Kw.
81	10.44	Eiffel Tower	FL 2600 m.	Paris ...	Time Signal in G.M.T. (Spark)	3 mins.	60 Kw.
82	11.57	Nauen ...	POZ 3100 m.	Berlin ...	Time Signal in G.M.T. (Spark)	8 mins.	—

Ref. No.	G. M. T.	Name of Station.	Call Sign and Wave-length.	Situation.	Nature of Transmission.	Closing Time or Approx. Duration.	Approx. Power used.
SUNDAYS.							
	a.m.						
83	7.30	Frankfurt ...	— 470 m.	Germany ...	Morning Prayer	1 hour	1 Kw.
85	8.00	Leipzig ...	— 454 m.	Germany ...	Morning Prayer	1 hour	700 Watts.
165	8.00	Konigsberg ...	— 463 m.	E. Prussia	Morning Prayer	8.45 a.m.	1 Kw.
86	9.00	Komarow ...	— 1800 m.	Czecho-Slovakia.	Sacred Concert	1 hour	1 Kw.
87	9.23	Eiffel Tower	FL 2600 m.	Paris	Time Signal in Greenwich Mean Time (Spark).	3 mins.	60 Kw.
166	9.30	Munich ...	— 485 m.	Bavaria ...	Sacred Concert	10.30 a.m.	1 Kw.
89	10.00	Eiffel Tower	FL 2600 m.	Paris	Time Signal in Greenwich Sidereal Time (Spark).	5 mins.	60 Kw.
90	10.00	Kbel ...	— 1160 m.	Prague ...	Classical Music	1 hour	1 Kw.
92	10.00	Radio-Wien ...	— 530 m.	Vienna ...	Concert	2 hours	1 Kw.
191	10.15	Hamburg ...	— 395 m.	Germany ...	Concert	11.15 a.m.	700 Watts.
93	10.30	Lyons ...	YN 550 m.	Lyons ...	Gramophone Records ...	11 a.m.	300 Watts.
94	10.30	Stuttgart ...	— 443 m.	Wurtemberg	Classical Concert... ..	1 hour	1 Kw.
192	10.30	Munich ...	— 485 m.	Bavaria ...	Sacred Concert	11.30 a.m.	1 Kw.
95	10.44	Eiffel Tower	FL 2600 m.	Paris	Time Signal in G.M.T. (Spark)	3 mins.	60 Kw.
96	10.30	Konigswusterhausen.	LP 2800 m.	Berlin ...	Concert	11.50 a.m.	6 Kw.
97	10.55	Eiffel Tower	FL 2600 m.	Paris	Fish Market Quotations, followed by Weather Report.	12 mins.	5 Kw.
91	11.00	Breslau ...	— 418 m.	Silesia ...	Concert	1 hour	1.5 Kw.
98	11.00	Stockholm ...	— 440 m.	Sweden ...	Divine Service	12.15	500 Watts.
101	11.57	Nauen ...	POZ 3100 m.	Berlin ...	Time Signal in G.M.T. (Spark)	3 mins.	—
	p.m.						
102	12.45	Radio-Paris ...	SFR 1780 m.	Clichy ...	Concert, followed by News ...	2.00 p.m.	8 Kw.
108	2.00	Munich ...	— 485 m.	Bavaria ...	Concert	3.00 p.m.	1 Kw.
104	3.00	Breslau ...	— 418 m.	Silesia ...	Children's Stories	3.45 p.m.	1.5 Kw.
105	3.00	Stuttgart ...	— 443 m.	Wurtemberg	Light Orchestra	5.00 p.m.	1 Kw.
107	3.00	Frankfurt ...	— 470 m.	Germany ...	Children's Corner	4.00 p.m.	1 Kw.
167	3.00	Zurich ...	— 515 m.	Switzerland	Local Hotel Concert	5.00 p.m.	500 Watts.
106	3.10	Radio-Wien ...	— 530 m.	Vienna ...	Afternoon Concert	5.00 p.m.	1 Kw.
168	3.30	Konigsberg ...	— 463 m.	E. Prussia	Light Orchestra	4.30 p.m.	1 Kw.
169	3.30	Voxhaus ...	430 & 505 m...	Berlin ...	Light Orchestra	5.00 p.m.	1 Kw.
170	3.30	Leipzig ...	— 454 m.	Germany ...	Light Orchestra	5.00 p.m.	700 Watts.
171	4.00	Frankfurt ...	— 470 m.	Germany ...	Light Orchestra	5.00 p.m.	1 Kw.
193	4.00	Frankfurt ...	— 470 m.	Germany ...	Sacred Concert	1 hour	1 Kw.
196	4.45	Hamburg ...	— 395 m.	Germany ...	English Conversation	6.15 p.m.	700 Watts.
172	4.45	Stuttgart ...	— 443 m.	Wurtemberg	Concert	6.00 p.m.	1 Kw.
110	4.45	Radio-Paris ...	SFR 1780 m.	Clichy ...	Concert, followed by News ...	1 hour	8 Kw.
111	5.00	Radio-Belg. ...	SBR 265 m.	Brussels ...	Concert	1 hour	2.5 Kw.
204	5.00	Kbel ...	— 1160 m.	Prague ...	Concert by Radio Trio ...	7.00 p.m.	1 Kw.
180	6.00	Barcelona ...	EA J1 325 m.	Spain ...	Concert	11 p.m.	650 Watts.
112	6.00	Eiffel Tower	FL 2600 m.	Paris	Concert, followed by News ...	1 hour	5 Kw.
114	7.00	Radio-Wien ...	— 530 m.	Vienna ...	Concert	8.30 p.m.	1 Kw.
118	7.00	Konigsberg ...	— 463 m.	E. Prussia	Concert	9.00 p.m.	1 Kw.
119	7.00	Hamburg ...	— 395 m.	Germany ...	Concert	9.00 p.m.	700 Watts.
120	7.00	Eiffel Tower	FL 2600 m.	Paris	General Weather Forecast ...	8 mins.	5 Kw.
125	7.00	Stuttgart ...	— 443 m.	Wurtemberg	Concert	9.15 p.m.	1 Kw.
173	7.00	Frankfurt ...	— 470 m.	Germany ...	Entertainment provided by "Frankfurter Zeitung."	10.00 p.m.	1 Kw.
121	7.15	Lausanne ...	HB2 850 m.	Switzerland	Concert	8.30 p.m.	300 Watts.
122	7.15	Zurich ...	— 515 m.	Switzerland	Concert	9.00 p.m.	500 Watts.
123	7.15	Leipzig ...	— 454 m.	Germany ...	Symphony Concert	8.40 p.m.	700 Watts.
116	7.00	Munster ...	— 410 m.	Westphalia	Classical Concert... ..	9.00 p.m.	1.5 Kw.
176	7.00	Copenhagen ...	— 750 m.	Denmark ...	Concert, followed by News ...	9.30 p.m.	2 Kw.
124	7.30	Breslau ...	— 418 m.	Silesia ...	Light Orchestra	9.00 p.m.	1.5 Kw.
174	7.30	Munich ...	— 485 m.	Bavaria ...	Concert	10.0 p.m.	1 Kw.
175	7.30	Radiofonica Italiana.	— 425 m.	Rome ...	Concert, followed by Late News	9.30 p.m.	4 Kw.
126	7.40	Ned. Seintoesl Fabriek.	NSF 1060 m.	Hilversum	Concert	10.10 p.m.	3 Kw.
127	8.30	Radio-Belg. ...	SBR 265 m.	Brussels ...	Concert, followed by News ...	10.10 p.m.	2.5 Kw.
128	8.30	Radio-Paris ...	SFR 1780 m.	Clichy ...	Detailed News Bulletin... ..	9.00 p.m.	8 Kw.
129	8.30	Ecole Sup. des P.et Tgs.	FPTT 450 m.	Paris	Concert or Lecture. May begin 15 mins. earlier or later.	10.30 to 12 p.m.	500 Watts.
132	9.00	Radio-Iberica	RI 392 m.	Spain ...	Concert	midnight	3 Kw.
130	9.00	Radio-Paris ...	SFR 1780 m.	Clichy ...	Concert, followed by Dance Music	11.00 p.m.	8 Kw.
105	9.00	Hamburg ...	— 395 m.	Germany ...	Dance Music	10 p.m.	700 Watts.
131	9.30	Petit Parisien	— 345 m.	Paris	Concert (Items announced in English as well as French).	11.30 p.m.	800 Watts.
133	10.00	Eiffel Tower	FL 2600 m.	Paris	Time Signal in Greenwich Sidereal Time (Spark).	3 mins.	60 Kw.
134	10.44	Eiffel Tower	FL 2600 m.	Paris	Time Signal in G.M.T. (Spark)	3 mins.	60 Kw.
135	11.57	Nauen ...	POZ 3100 m.	Berlin	Time Signal in G.M.T. (Spark)	8 mins.	—

Ref. No.	G. M. T.	Name of Station.	Call Sign and Wave-length.	Situation.	Nature of Transmission.	Closing Time or Approx. Duration.	Approx. Power used.
SPECIAL DAYS							
194	p.m. 3.00	Stuttgart ...	— 443 m.	Wurttemberg	Children's Corner ...	4.30 p.m.	1 Kw.
137	4.00	Lausanne ...	HB2 850 m.	Switzerland	Mon. Children's Stories ...	1 hour	300 Watts.
180	5.30	Belgrade ...	HF 1650 m.	Serbia ...	Tues., Concert ...	1 hour	500 Watts.
					Thurs.,		
					Sat.		
140	5.15	Zurich ...	— 515 m.	Switzerland	Mon., Children's Corner ...	5.50 p.m.	500 Watts.
					Wed.,		
					Fri.,		
141	5.15	Zurich ...	— 515 m.	Switzerland	Thurs., Lecture ...	30 mins.	500 Watts.
142	5.40	Ned. Seintoesl Fabriek.	NSF 1060 m.	Hilversum	Mon., Children's Hour ...	6.40 p.m.	3 Kw.
203	6.00	Gotenborg ...	SMZX 460 m.	Sweden ...	Tues., Concert ...	8 p.m.	300 Watts.
147	7.00	Stockholm ...	— 440 m.	Sweden ...	Fri. Concert ...		
148	7.40	Smith and Hooghoudt.	PA5 1050 m.	Amsterdam	Sat. Concert ...	10 p.m.	500 Watts.
150	8.40	Ned. Radio In.	PCGG 1070 m.	The Hague	Wed. Concert ...	9.40 p.m.	500 Watts.
151	8.40	Amsterdam ...	PX9 1060 m.	Holland ...	Mon. Concert ...	10.10 p.m.	1.3 Kw.
152	8.40	Ned Seintoesl Fabriek	NSF 1060 m.	Hilversum	Mon. Concert ...	10.40 p.m.	600 Watts.
					Fri. Concert ...	9.40 p.m.	3 Kw.
153	9.00	Le Matin ...	SFR 1780 m.	Paris ...	2nd & 4th Sat. Special Gala Concert	10.50 p.m.	10 Kw.
197	9.00	Breslau ...	— 418 m.	Silesia ...	Dance Music, Thursday ...	10 p.m.	1.5 Kw.
198	9.00	Hamburg ...	— 395 m.	Germany ...	Dance Music, Thursday ...	10 p.m.	700 Watts.
199	9.00	Frankfurt ...	— 470 m.	Germany ...	Special programme by local artists, Mon., Wed. Thu., Fri.	10 p.m.	1 Kw.
200	9.00	Munich ...	— 485 m.	Bavaria ...	Special Concert, Tues., Thu., Sat.	10 p.m.	1 Kw.
210	9.00	Radio-Wien	— 530 m.	Vienna ...	Dance Music, Wed., Sat. ...	10 p.m.	1 Kw.
154	9.30	Petit Parisien	— 345 m.	Paris ...	Tues., Concert (Items announced in English as well as French).	11.30 p.m.	400 Watts.
155	10.00	Radio-Paris ...	SFR 1780 m.	Clichy ...	Two Evenings per Week—Dance Music.	10.45 p.m.	8 Kw.

Obtaining Small Variable Capacities

In those cases where it is desired to reduce the capacity of existing variable condensers one may place a fixed condenser in series with the variables. When two condensers of the same value are placed in series the total capacity is half that of either of them. Thus if the existing A.T.C. has a maximum capacity of .0005 μF we can bring this down to .00025 μF by mounting a fixed condenser of .0005 μF in series with it. In the closed circuit an existing maximum capacity of .0003 μF can be reduced to .00015 μF by the addition of a fixed condenser of the same value as the variable.

For capacities of different values in series the formula is $\frac{1}{C} = \frac{1}{C_1} + \frac{1}{C_2} \dots$, where C is

the resultant capacity and C₁, C₂, . . . etc., the individual capacities of the condensers.

It should be noted that it is

essential that the fixed condensers used in the way suggested should be of the very best quality.

R. W. H.

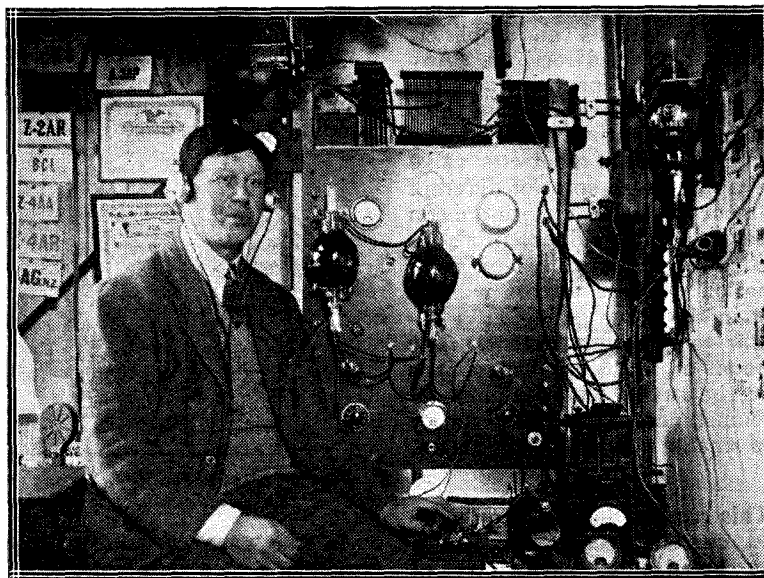

Mr. Gerald Marcuse, the well-known experimenter, who recently established communication with Brazil.

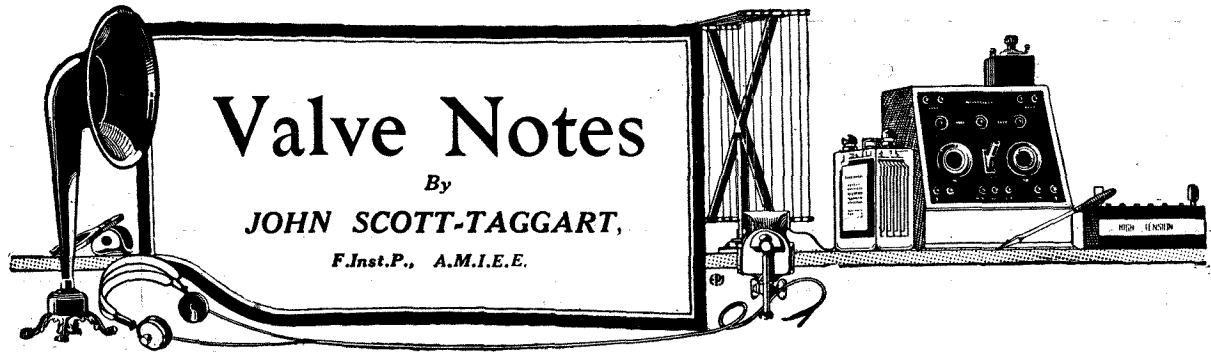

Double Rectification Effects

THE form of distortion which has received very little consideration, but which is nevertheless prevalent in certain types of circuits, is that due to two sets of rectification

at one or other of the bends in the characteristic curve, but the phenomenon will occur at almost any point in the curve, provided there is some curvature, using this word in its ordinary popular sense. If the curve is absolutely

types of valves; but in amplifying high-frequency currents in the ordinary way, we ignore any distortion of the high-frequency currents, for the simple reason that the ultimate effect is negligible.

An Example

If, for example, the first, second, third and fourth valves of a multi-stage high-frequency amplifier rectify a little, there will be no noticeable effect if the valves are coupled, for example, by high-frequency transformers or tuned anode circuits, or by some neutrodyne arrangement. Each valve may introduce a little distortion, but the total sum is negligible in nearly all cases.

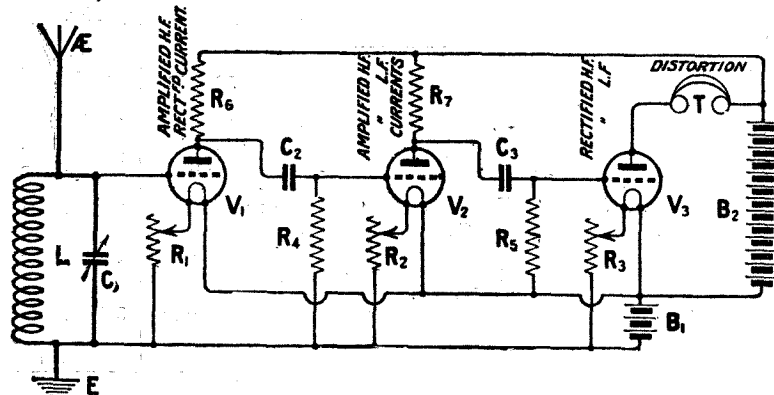

Fig. 1.—A resistance coupled H.F. amplifier circuit in which double rectification may cause distortion.

processes which mask each other and cause distortion, which may, in certain cases, be very serious.

The double rectification effect is due to the fact that a valve, intended to act as an amplifier, actually acts as a rectifier. Any beginner can prove that the average amplifying valve also rectifies, by cutting out the leaky grid condenser of a detector valve and applying all sorts of different filament voltages, high-tension potentials and grid potentials to the valve. Practically any combination of these factors will result in the valve acting as a detector to a certain extent. The amount of rectification may, it is true, be small, but in almost all circumstances there will certainly be a small amount of rectification.

Rectification

This rectification may be due to grid current rectification, or it may be due to asymmetry of the anode current curve. Not only will rectification be obtained

straight and the portion used lies well to the left of the grid zero ordinate, there is not much chance of rectification.

Distortion

Valves are not yet perfect, and even the best will, in most circumstances, introduce a certain amount of distortion.

Resistance Coupling

When, however, we use resistance coupling, or some method of coupling which also serves to pass on the low-frequency currents as well as high-frequency currents, then troubles may be experienced. This is the case in resistance-coupled amplifiers and amplifiers using iron choke coils for high-frequency amplification. These latter are rarely used nowadays, but even a very large air-

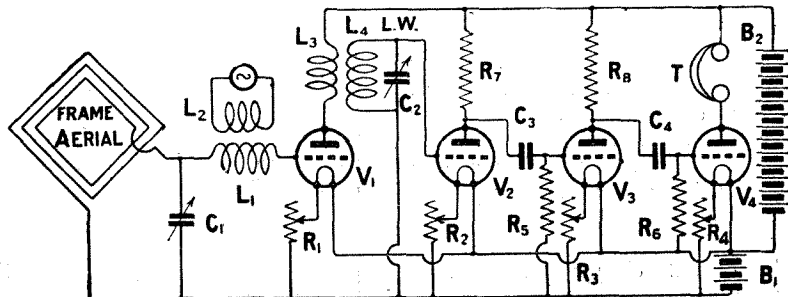

Fig. 2.—A supersonic heterodyne circuit with resistance coupling on the L.W. side, which may give the same distortion as in Fig. 1.

In the case of low-frequency amplifiers, we generally avoid distortion by suitably operating the valves and using the right

core choke will pass on a certain amount of low-frequency energy.

Fig. 1 will show, more or less, clearly what I wish to explain.

Double Rectification

It will be seen that the first valve acts as a high-frequency amplifier, as, in fact, does the second, two anode resistances being employed. The third valve acts as a detector, and it is assumed, of course, that the receiver is being used on a wavelength of, say, 1,000 metres or upwards. Under these circumstances the receiver will work quite well, but a certain amount of distortion may occur, due to a double rectification effect.

The Cause

The trouble is caused through the first valve acting, not only as a high-frequency amplifier, but also as a detector. This detector action is almost inseparable from a valve, as explained before, and the result is that through the first anode resistance we have passing, not only the amplified high-frequency currents, but also a certain rectified current, which may be small, but which is nevertheless present. This rectified current takes the form of low-frequency currents. The high-frequency currents passing through the first anode resistance will set up potentials across it which will be communicated to the grid of the second valve, which is also an amplifier. The high-frequency currents which now pass through the anode resistance of the second valve will set up potential differences across that resistance which will be communicated to the grid of the third valve; the amplified high-frequency currents will be rectified by the third valve and signals will be heard in the telephones.

L.F. Currents

At the same time, however, the small rectified low-frequency currents passing through the first anode resistance will also be communicated to the grid of the second valve, which will also amplify these currents. We consequently have in the anode circuit of the second valve, amplified low-frequency currents due to the initial rectification effect produced by the first valve. These low-frequency currents now pass on to the grid circuit of the third valve and are partially rectified. We have, passing through the telephones, therefore, the genuine desired low-frequency currents

due to the rectification of the incoming high-frequency currents, but we also have a peculiar rectified low-frequency current which will cause a distortion effect, which, in a multi-stage receiver, may become really disagreeable.

Perhaps we have heard very little about this effect, because resistance coupled receivers are practically never used for telephony reception. When resistance amplifiers are used, they are almost entirely used for low-frequency amplification.

Spark Signals

The resistance coupled high-frequency amplifier was chiefly popular for the reception of spark signals, and occasionally for long-wave continuous wave reception. The danger, however, with spark signals is negligible, because it does not matter whether they are slightly distorted or not; but in the case of telephony signals, the question is a vital one, and if resistance coupling is to be used, then it is extremely important that each valve should be operated so as to act purely as an undistorting high-frequency amplifier. It is to be noticed, of course, that the rectification effect may take place at any valve in the chain, and that it is not necessarily the first valve which causes the trouble. It is, however, worse if the first valve causes the trouble, because there will be more stages of low-

frequency amplification before finally the distorting currents are passed through the telephones.

Super-Heterodyne Receivers

A particular case which has drawn my attention afresh to this matter is in connection with supersonic heterodyne receivers, where resistance coupling is used for the long-wave (or intermediate frequency) amplifier. In Fig. 2 will be seen a theoretical circuit for a supersonic heterodyne receiver, in which stages of resistance coupling are used for long-wave amplification. The first valve acts as a detector, and the rectified component has a wavelength of, say, 7,000 metres.

The Reason

This is due to the rectification of the beats produced by the incoming signals and the local oscillations. The currents corresponding to a wavelength of 7,000 metres are now amplified by resistance amplification; but if the first amplifying valve (the second valve of the series in the figure) detects in any way, as it probably will, the 7,000-metre signals will be immediately detected in the first amplifying valve, and a low-frequency component will pass through the anode resistance of this first amplifying valve. This low-frequency component will now be amplified by the next resistance-coupled valve, and the telephones will have passing

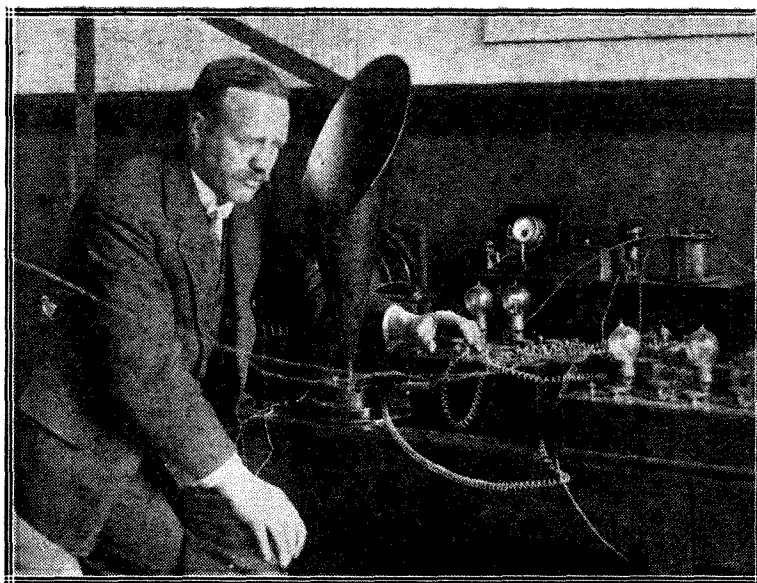

Major Vitty, who is in charge of the Wireless Department at Scotland Yard.

through them signals due to the rectification of the 7,000-metre signals.

As a matter of fact, however, we do not want the telephones to receive these currents at all. We only want them to receive the rectified currents corresponding to 7,000 metres, after these have been amplified by the stages of high-frequency resistance-coupled amplification.

Self-Oscillation

We have in effect low-frequency currents which have been amplified by the resistance amplifier, and which are due to rectification by the first valve of the, say, 7,000-metre signals, and we have also the legitimate currents, also at low frequency, due to rectification of the 7,000-metre currents *after* they have been amplified by the resistance amplifier acting as a high-frequency amplifier. The resultant distortion in the telephones may be very considerable, and this may occur even though a good deal of trouble is taken to endeavour to make all the valves act as amplifiers purely and simply.

A point which is worth mentioning at this stage is that it is extremely difficult on a multi-stage high-frequency amplifier to avoid a tendency towards self-oscillation, and the means for

preventing self-oscillation, such as positive grid bias, will usually also introduce a considerable amount of rectification.

The Remedy

A full discussion of the methods which may be adopted for overcoming these troubles and enabling undistorted results to be obtained will be discussed in next week's issue in these notes.

An Anti-Capacity Valve Holder

THE diagrams of this valve-holder are almost self-explanatory. Instead of using ordinary sockets or holders, drill

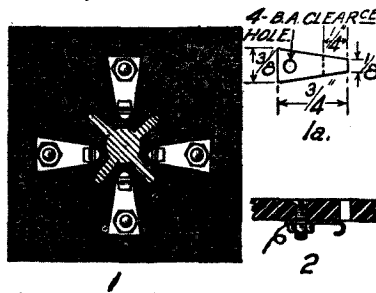

Constructional details of the valve-holder.

$\frac{1}{8}$ -in. diameter holes for the valve legs in the panel, and cut pieces of thin springy brass or copper

strip to the dimensions given in the accompanying figure, bending them and then fixing to the panel by screws as shown. The bending can easily be done with a pair of round-nosed pliers. The risk of inter-capacity can be further reduced by drilling a centre hole and making saw cuts between the sockets as shown by the shaded portion. It is convenient to use 4 B.A. counter-sunk screws and nuts for fixing.

P. D.

A Stable Three-Valve Receiver

SIR,—Having made a bench-trial of the "Stable Three-Valve Receiver," described by Mr. C. P. Allinson in your journal of December 31, 1924, I should like to say how extremely pleased I am with its performance for long-distance reception, and for its ability to completely eliminate the local main station at the short range of $1\frac{1}{2}$ miles when using the wave-trap incorporated in the circuit given. Shortly after connecting up and tuning in with a wavemeter I picked up clearly in the 'phones the relay station at Nuremberg, Germany, and later Stuttgart, Ecole Supérieure, and Vienna—but for some reason or other I did not have much success with the B.B.C. stations. The tuning is extremely sharp, and the set will apparently require some practice in handling, but I think it is well worth a good trial by those situated close to a main station, who are anxious to pick up distant transmissions without local interference. But if near the coast the elimination of the local station seems to intensify the interference from ships' morse, at times, which is, of course, heard more clearly in consequence of the silence of the local station. Possibly this could also be trapped, to some extent, by the same method. But whether used with the wave-trap or not I think the set is one of the most useful three-valvers ever described in your journals.—Yours faithfully,

C. F. K.

Bournemouth.

THE LATEST GERMAN STATION

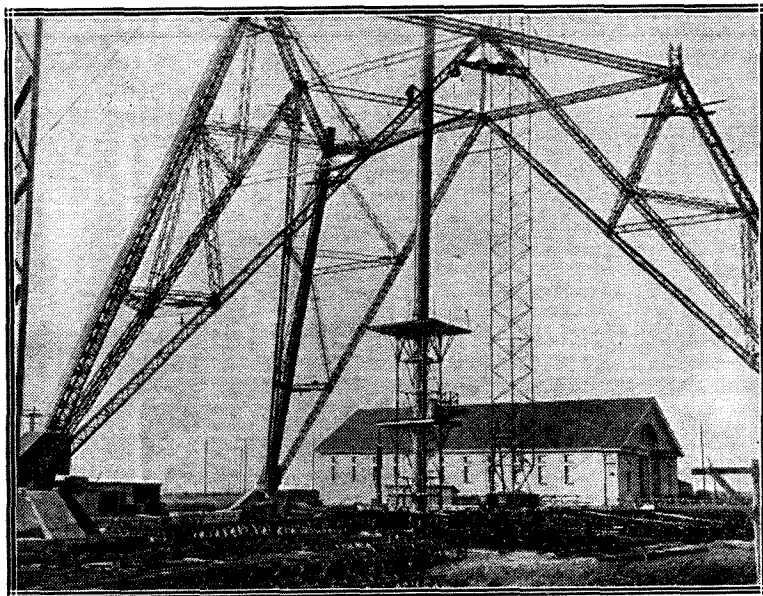

Our photograph shows the great 255 metres tower in erection, with one of the transmitting houses in the background, at the new station at Konigswusterhausen.

OUR NEXT ISSUE

Full constructional details will be given of how to build the super-heterodyne unit for use with the "Super 5" Receiver.

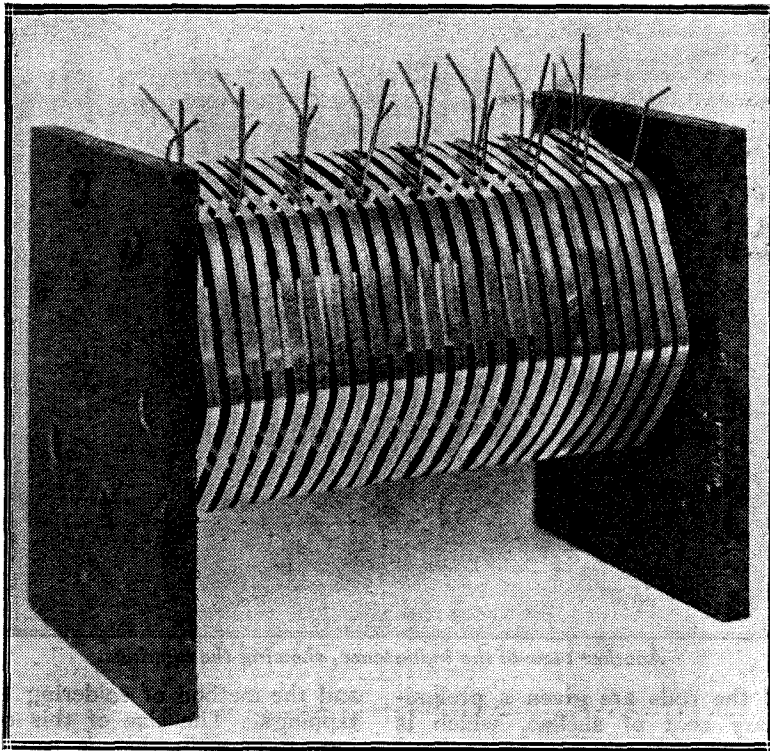

The complete inductance, showing staggered tapping points on each turn

AN essential point in a wireless transmitter is, of course, the tuning coil, and I had not gone far in my transmitting experiments before I discovered that transmitting inductances were not a readily procurable commercial product. Furthermore, having a strong predilection for the easiest way of doing a thing, I did not relish undertaking the construction of a transmitting inductance along the lines described by many writers. Another point was that in work of this kind I prefer to consider the position of the average experimenter, so that, although I have a lathe available, I did not see why it should be brought into play for the construction of this inductance.

Transmitting Requirements

The main requirements of a transmitting inductance are that it should be wound as far as possible without solid dielectric in the field, that the turns should be spaced, and that the high-frequency resistance of the conductor used should be low. It is usual in the construction of such coils to use either copper tube, strip or heavy gauge wire, such as No. 12 or 14 single copper. Of the three the least trouble-

some to wind is the strip and the most difficult the tube. Indeed, I doubt whether anyone who has not access to a machine shop can make a satisfactory inductance from copper tube.

First Experiments

The first inductance I made (it happens to be illustrated on page 521 of my article in *Wireless Weekly*, Vol. 5, No. 14), was constructed from sections of 4-in. ebonite tube to which were screwed five strips of 3-16th ebonite, in which a number of equally-spaced notches (six to the inch) had been filed with a rat-tail file. The size of the file chosen for this work was slightly larger in diameter than ordinary 7/22 aerial wire, this latter being wound on the skeleton former so as to fall in the grooves. It is a comparatively easy matter to wind a transmitting inductance in this fashion, for the amount of hand work is not great. Tapping points can be made by soldering, to the bare turns of wire, short projecting pieces which can conveniently be No. 16 gauge or larger.

The best form of inductance in a transmitting circuit, of course, depends upon the circuit used. If the simple direct-coupled Hart-

Making a Start in Transmission

By **PERCY W. HARRIS,**
M.I.R.E.,

Assistant Editor.

*A further article of this series
dealing with some efficient and
easily made inductances.*

ley circuit, or the Colpitts is adopted, the inductance can consist of a single coil. If a Meissner, inductively-coupled-Hartley, or what the Americans call the "Tickler" coil, circuits are used, you will need the form of inductance to which another coil can be variably coupled. The construction of coils of this latter type is left for a further article. Meanwhile I would like to deal with a few points on the construction of a coil suitable for use on the amateur wavelengths, and particularly on the new shorter wavelengths, in such a circuit as the Hartley.

A Trouble

The trouble about a coil wound with thick wire on a skeleton former is that if the tension is made sufficiently strong to hold the wire there is a great tendency to bend the strip. This gives a looseness to some parts of the coil, and, in any case, the handling of the thick gauge solid wire is by no means easy.

H.F. Resistance

The high-frequency resistance of solid wire differs from the direct current resistance, the difference being progressively greater as we increase the thickness of the wire. The reason, of course, is obvious to any reader who understands that high-frequency currents travel only on the surface of a conductor. The penetration into a conductor for the very short wavelengths is very slight, and we could take

out a large portion of the centre of a wire (thus converting it into a tube) without affecting the high-frequency resistance a jot. We thus use, in a thick wire inductance, considerably more metal than is needed, and serious eddy-current losses may be set up in it. Tube, as I previously mentioned, is most difficult to handle, and there remains strip, which is often difficult to obtain commercially.

A New Pattern

I have now found a way of making an efficient inductance with very low losses, and which is far simpler to wind than even a good single layer inductance coil in a receiver. It merely consists of two wooden end pieces in which are bored with a 3/8th in. bit six holes to take the ebonite rod. These rods are 12in. in length, 5/8 diameter, and can be obtained without difficulty through any dealer. After the holes have been made in the two end pieces, and the rod pushed into place, a hole to take a 6BA metal screw is tapped in one end of the uppermost rod. A clearance hole for this screw is then made in the copper strip, the screw passed through the copper

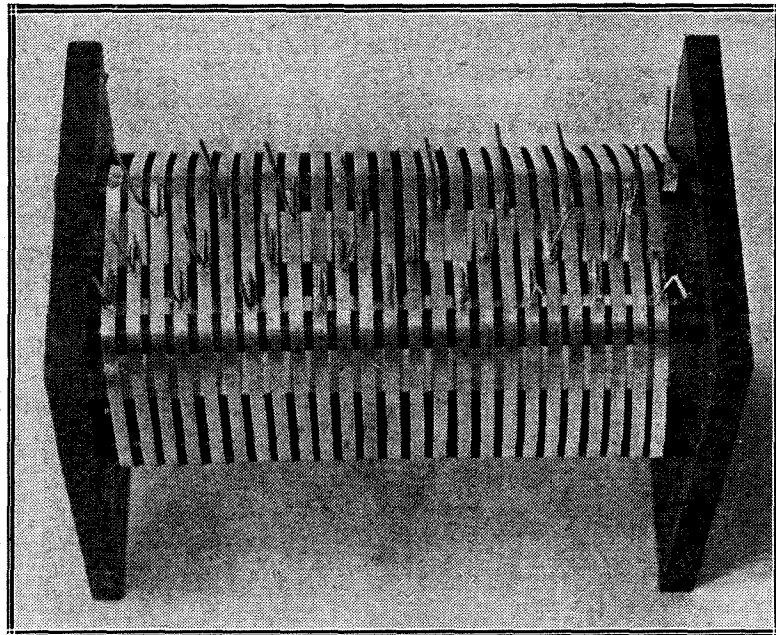

Another view of the inductance, showing the tappings.

if the rods are given a preliminary coat of shellac, which is left until "tacky" before the strip is wound on. The strip is now wound on by hand, spacing being kept about equal to the width of the strip, until the whole former is filled. Another hole is now tapped in the uppermost rod and the end of the coil secured

and the method of soldering the tappings. The size of this coil former is such that it can be conveniently placed on the back of the standardised transmitter described in the previous article. I am at present using the coil shown on my transmitter with excellent results, Burndeft clips being used on the end of six flexible leads for the various connections. Signals are reported R6 in Finland (over 1,000 miles), with an input of 10 watts, using this coil.

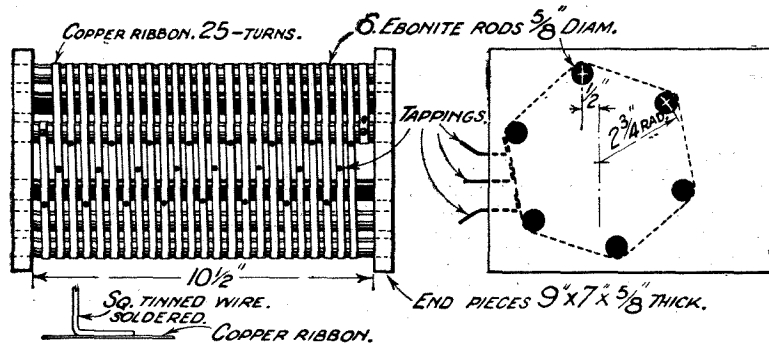

Constructional details of the inductance shown in the photographs.

strip and screwed into place in the ebonite rod. This grips the strip securely.

Copper Strip Aerial

I have found that the Radi-ohm copper strip aerial sold in 100-ft. lengths is excellent for making transmitting inductances. It is very flexible, inexpensive, and is no more trouble to wind on the rod than ordinary linen tape. Owing to its flat surface it "stays put" without difficulty, and can be firmly secured in place

in a similar fashion to that already described. By arranging the rods as shown, you will see it is easy to make wire-tapping points on every turn of the coil for clip connections. It is preferable to cut out the ends of the wooden end pieces, so as to remove still more dielectric from the field, but if good dry wood is used little trouble will be experienced in this direction.

Tappings

The illustrations show further details of how the coil is made

X-Shaped Formers

Another form of transmitting inductance can be made by taking two X-shaped formers, such as are used for what is now termed the "Harris" coil, and securing to the ends four strips grooved to take bare wire with suitable spacing. The grooves can be simply as follows: Take a strip of ebonite (it need be no thicker than 3-16 in.) This strip should be of the length you require the coil former to be, and four times the width of the strips to be used. Carefully mark down the middle of the wide strip a line so as to divide the strip into two portions, and again subdivide the two portions so that you have four equal width strips marked out. Now down each of the side markings (not the central line), mark out equally spaced points (six or eight to the inch is a convenient size), and drill through these

points with a size of drill slightly larger than the diameter of the bare wire you desire to wind on to the former. When this has been done, and both sides have been drilled, saw down the lines, first down the middle so as to obtain two double-width strips, with a row of holes down the middle of each, and then down the middle of each of these double-width strips, so as to divide the strips exactly through the bored holes. You will then have four strips, along the edges of which are semi-circular notches which will take the bare wire without slipping. You can then secure these strips to the X former and wind in the bare wire, thus obtaining a coil of practically square shape, to which clips can be attached or soldered connections made with ease.

Another Method

Still another simply-made inductance former (more simple than any of the others) consists in using plain ebonite strips five or six in number, if convenient, screwed to three or more rings, as mentioned in the first type of inductance. Along these flat strips attach by shellac or some other suitable means four strips of corrugated cardboard such as is used for wrapping bottles and similar articles. The strips should be given a preliminary treatment by drying and dipping into paraffin wax, surplus wax being drained off. They should be dipped quickly in the wax, or the heat will melt the glue which secures the corrugations. These strips will serve as bases for the wire which is wound on to the coil. While coils wound in this fashion may not appear so elegant as some others, they are exceedingly simple to make, and will serve many purposes in transmission experiments.

Use of Flexible Wire

Excellent temporary inductances of not quite so high efficiency as those previously described, can be rapidly wound on dry cardboard tube, of suitable size, using for this purpose the heavy rubber-covered single flex obtainable from any electrical stores. This flex is much heavier than that used for suspending electric lights, and the thick in-

sulating covering serves to space the turns of wire within, when the flex is wound with turns touching. The flex can be threaded through holes in the cardboard former and pulled on quite tight, so that it will not slip, even when pressure is ap-

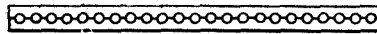
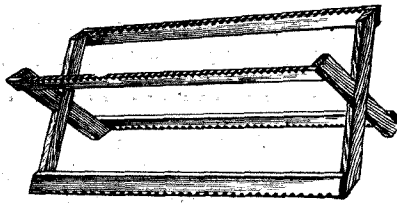

Illustrating the X-shaped former, and the method of making the slots.

plied. I use such a form of inductance when I see reports on some particular transmitting circuit supposed to give specially good results. If it seems promising, the inductance can subsequently be made up in one of the forms just described.

Whilst it is sometimes convenient to use clips which grip the bare wire of the coil, I have found it quite satisfactory to solder short lengths of wire to each turn of the coil and make a connection to these short wires rather than to the coil itself.

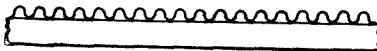
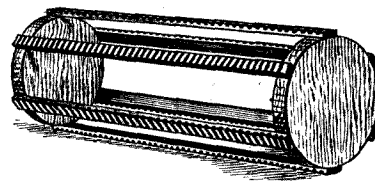

Corrugated cardboard may be used to space the turns of a transmitting inductance.

The tapping points can be well staggered so as to avoid capacity effects between them, and if the staggering is done regularly this makes it very simple to count the number of turns in circuit when required. Clix sockets can be easily soldered to the projecting wires in those cases where a good sound electrical contact to carry quite a large current is required.

It is not always necessary for the whole of the tuning coil to be of the same heavy gauge, as some portions of it may carry very small currents.

Whatever form of transmitting inductance is used, be careful to place it in such a position that metal objects and large masses of material do not come too close to it, or you may have considerable losses which will neutralise the efficiency of the inductance itself.

A Note on Aerial Series Condensers

For tuning your set to the very short wavelengths now in vogue (for working on which, by the way, a special permit is required), you can use one of the Navy type large brass-plate variable condensers, which are still to be obtained for less than a couple of pounds from disposal merchants. They were originally designed to be used with oil, and the plates are mounted in a sealed glass jar for this purpose. They can, however, be used with air dielectric, and the spacing of the plates kept sufficiently wide to prevent sparking over when used in low-power transmitters. A series condenser in the aerial is very useful for fine tuning, and you will be surprised what a slight variation of the condenser makes an appreciable difference to the readings of the aerial ammeter.

POZ

SIR,—It may be of interest to experimenters in Europe to know that POZ was heard recently in Mandated Territory of New Guinea at Rabaul for three mornings in succession on 75 metres (local times 3 a.m. to 6.15 a.m.) and 6 p.m. to 9.15 p.m. middle European zone time. POZ's C.W. Morse was readable on a loud-speaker at a distance of 50 ft. from the instruments; the voice was not readable, though audible, through bad static conditions. The distance from Nauen to Rabaul is approximately 9,000 miles. Two V24's were used for reception by 'phones and four valves for reception by loud-speaker. The Rabaul station is situated at Bitu-Paka, 30 miles from Rabaul, and was captured from the Germans on September 12, 1914, being only in course of erection on that date.—Yours faithfully,

J. C. DRAFFIN.

Bitu-Paka, Rabaul.

A Semi-aperiodic Aerial Coupling for "Neutral Grid" Circuits

By A. D. COWPER, M.Sc., Staff Editor.

The "neutral-grid" method of coupling, which is an interesting means of obtaining stability in H.F. amplifiers, was described in our issue of Oct. 29 of last year.

CORRESPONDENTS have raised the question as to the practicability of applying some form of semi-aperiodic aerial-coupling to their receivers, in order to utilise the stable "neutral-grid" high-frequency amplifying circuit described recently by the writer. In this, it will be remembered, the grid-plate capacity of the first valve (with the resulting electrostatic reaction feed-back) has been sufficiently neutralised by the simple device of a tapping-point made on the tuned-anode inductance near the H.T. plus end, and which now forms the "earth" point of attachment for the grid-circuit of the first valve. Full negative grid-bias can then be used, together with efficient sharp-tuning inductances everywhere; and the circuit is still stable enough to require a manageable degree of direct magnetic reaction by the usual swinging reaction coil.

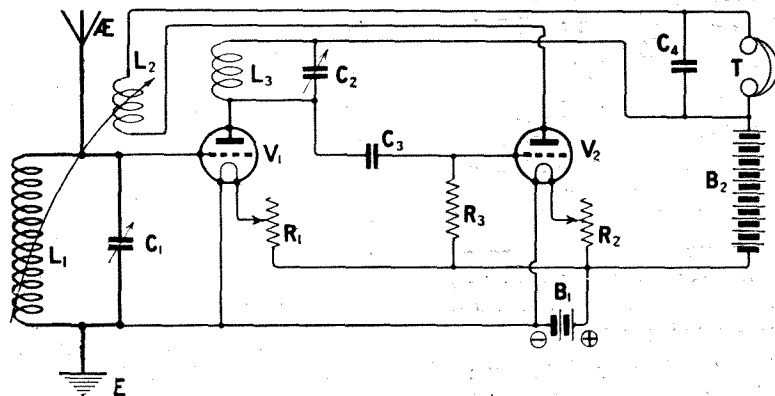

Fig. 1.—A simple form of H.F. tuned anode coupling.

But a loose-coupled first grid-circuit is required, and a three-coil tuner. This is to some a decided disadvantage, both on the score of apparatus requirements and on account of the extra tuning-point implied—apart from the notorious trickiness of the three-coil tuner.

method can readily be tried on existing receivers with minimum alterations.

The ordinary direct-coupled A.T.I. is replaced by a double tuning-coil, with a semi-aperiodic primary isolated from the tuned secondary for electrostatic effects of any magnitude, but sufficiently

A Suggestion

A suggestion which gives a definite working solution of the problem, which will be found easy

coupled magnetically to give efficient transfer of signal energy, and with an aerial-coil adjusted carefully to give this coupling

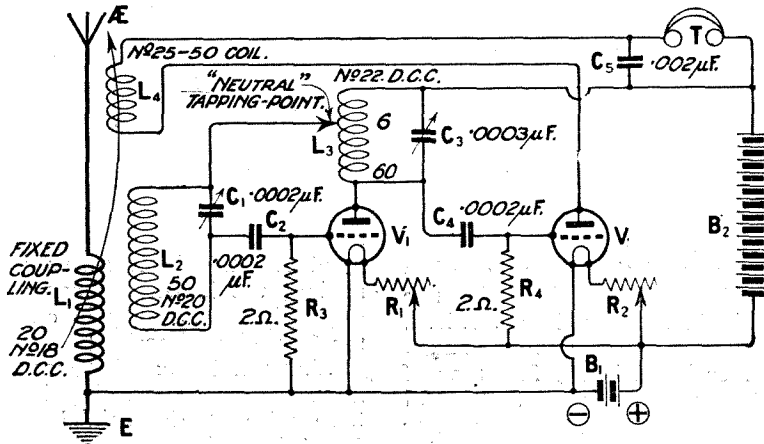

Fig. 2.—Transformation of the Fig. 1 circuit to "neutral grid" coupling with semi-aperiodic aerial.

to operate and very simple to construct at small expense, is given herewith, so that the

over the usual B.B.C. wavelength range, 300-500 metres, together with sufficient "periodic" effect to provide reasonable stability. If the loose-coupling is pushed too far by cutting down the aerial-coil turns below the 20 specified, signal strength and stability in this arrangement both suffer appreciably, and the circuit may become almost impracticably "lively."

An Essential

The smallness of the inevitable electrostatic coupling is an essential point, as on close examination of the circuit it will be seen that any capacity across the ends of the coils effectively short-circuits the stabilising turns in common with the anode inductance. The form of semi-aperiodic A.T.I. with the wires wound side by side on the same former is therefore inadmissible here.

The primary (which is not directly tuned, of course) consists of 20 turns of No. 18 S.W.G.

d.c.c. wire, wound in single layer on a $3\frac{1}{4}$ -in. diameter waxed-cardboard former, the ends being brought out through the centre and fitted with terminals for aerial and earth connections. This coil slides tightly inside the 4-in. diameter waxed-cardboard former, some $3\frac{1}{2}$ in. long, which carries the grid coil of 50 turns of No. 20 S.W.G. d.c.c. wire. The outer end of this is connected to the grid via an ordinary grid condenser (with leak of, say, 2 megohms to L.T. minus); the inner end, which is nearest to the earth end of the inside primary coil, is connected to the tapping-point on the anode coil, about $\frac{1}{10}$ th the way up from the H.T. plus end, i.e., at No. 5-7 turn on a 60-turn anode coil—the “neutral point” for our purposes. The grid-inductance is tuned over the range mentioned by a .0002 μ F actual low-minimum variable tuning condenser. The writer

obtained good results here with a J.B. ebonite-ended variable condenser. With some makes

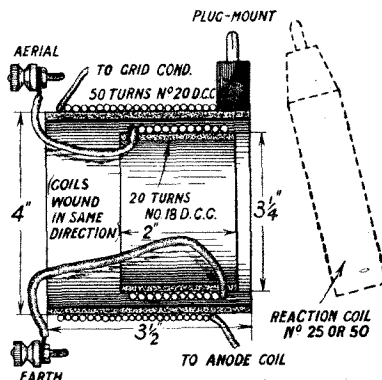

Fig. 3.—Details of the semi-aperiodic coupling coils.

the minimum may be above 350 metres; and a .00025 or .0003 μ F nominal is required to reach 500 metres.

In case easily-oscillating valves with high “M” and low im-

pedance are used, it may be necessary to make the anode tapping point rather higher up, at, e.g., the 7th or 10th turn, and to use a very small reaction coil as, e.g., No. 25 or even smaller.

The finished inductance is conveniently mounted on an ordinary ebonite coil plug by two screws (with large washers under the heads through the secondary tube at the “earth” end) and used in an ordinary two-coil tuner with a No. 50 or smaller reaction coil, as usual. The wiring of the set will have to be altered slightly to conform with the circuit diagram, the normal first grid circuit being cut at the “earth” end and connected to the tapping on the anode coil, whilst the grid condenser and leak to L.T. minus will have to be installed.

The coils should be lightly shellaced when finished, and baked to exclude moisture before using.

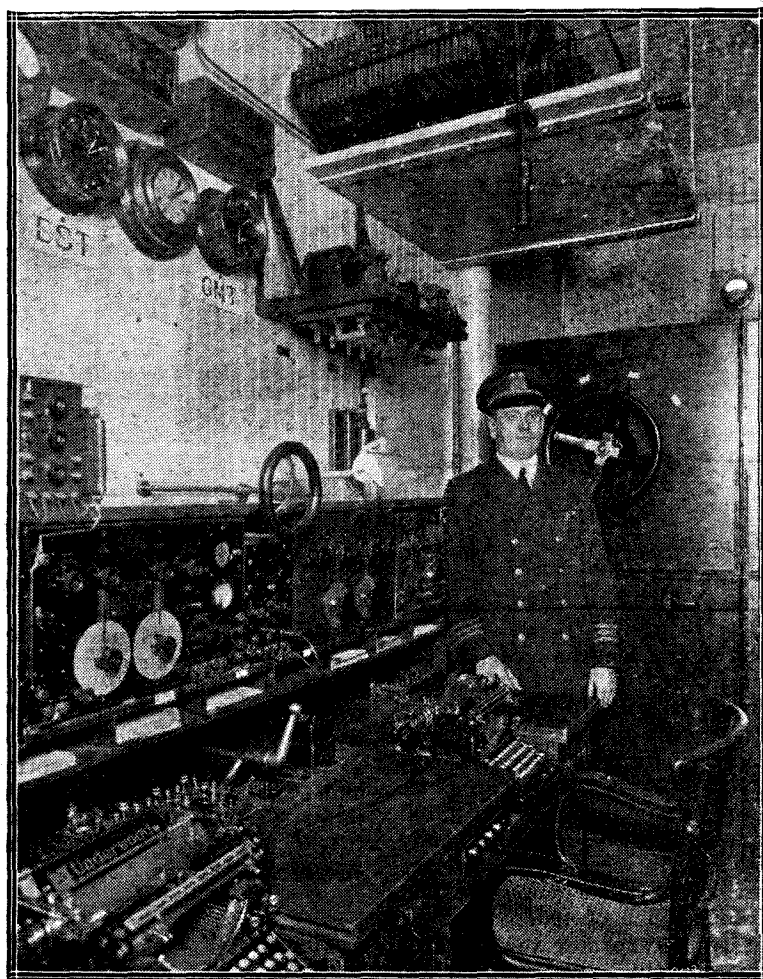

Our photograph shows some of the apparatus on board the s.s. “Leviathan,” together with the chief operator.

RADIO NOTES

Australian Radio Association

An association has recently been formed in Australia, under the name of the Institution of Radio Engineers of Australia, to protect and advance the interests of the wireless profession; and to promote experimentation and research in the science of radio. Wireless is of peculiar interest to Australia, and an association of this kind will do much to link the smallest continent more closely in every way with Europe and America.

Soviet Broadcasting

Russian radio, although practically unheard of abroad, has taken big strides in the past year. Many large stations under the control of the Union of Soviet Socialist Republics now broadcast regularly from Moscow, from Leningrad, and from Nijni-Novgorod. Moscow boasts two; the huge central station operating on a wavelength of 3,200 metres, and a smaller military station. In the afternoons, the former station broadcasts political news and weather reports; and in the evening musical programmes and items of news. The second station is much less powerful and broadcasts irregularly.

A Home-made Aerial Mast

The chief expense of an outside aerial, if one wishes to take advantage of height, is the mast at the free end. It is my intention to describe a mast which has stood the gales of the past year and is still as efficient and rigid as when erected. Perhaps the advantages of this mast will be more apparent when I say that the actual cost of materials was 10s. and the height 44 ft. A gas barrel mast of this height would cost at least 30s.

Construction

Constructional detail should be quite plain from the accom-

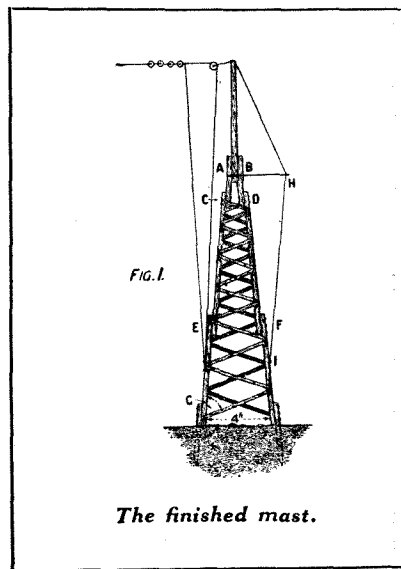

panying diagrams, the materials required being as follows:—
 42 ft. of batten 2 in. × 1 in.,
 45 ft. of 12 in. × 2 in., 36 ft. rough slating battens 1 in. × 3/4 in.,
 1 1/2 lbs. 2-in. wire nails, 2 dozen 2-in. wood screws, 1/2 dozen 3-in. bolts and nuts, wire for stays and one egg insulator to take the place of a pulley block. Proceed to assemble the lengths in a convenient situation, preferably near to the site of final erection, for although it is so light that it can be lifted with one hand at the point of balance, the length precludes manœuvring in restricted spaces. The lengths of batten used were based on the lengths supplied, which, in this case, were five of 15 ft. and one of

12 ft., which should be sawn in two.

Take one 15-ft. length of 2 in. × 2 in. and attach to it on each side at "A" and "B" the two short lengths of 2 in. × 1 in., using three screws each side and overlapping 3 ft. Attach to these the two 15-ft. lengths of 2 in. × 1 in., one each side, in a similar manner, again allowing a 3-ft. overlap at "C" and "D." Finally, with the nuts and bolts fix the two

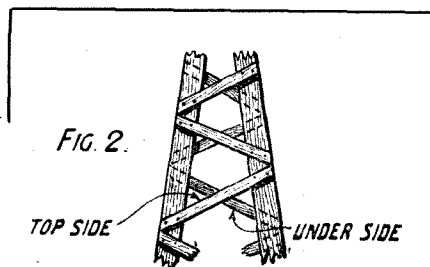

Details of how the side pieces are placed.



The manner in which the side pieces may be supported.

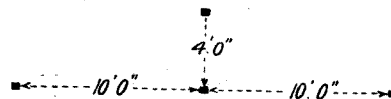

The positions for the pegs should be of these dimensions.

remaining lengths of 2 in. × 2 in. at "E" and "F," first boring completely through the 2-ft. overlap the three holes necessary for the bolts, not forgetting to put washers in place before tightening up the nuts. I am assuming you are not handy with carpentering tools, and are anxious to make a strong join without a lot of tenoning, etc., but to a carpenter these bolted joins will not appeal, and he will probably make a much neater job than I have done, for the mast I have in mind is made exactly

as described herewith, and is not a thing of beauty to the man with a carpenter's instincts. It is essentially the job of a man who can drive a nail and a screw without too much profanity, but who handles the chisel with some trepidation.

The Side Pieces

To resume, you have now a large sized replica of a tuning fork. By means of wooden pegs driven into the ground, space the ends apart 4 ft. (or a 4-ft. length of timber wedged across the bottom, will do) and keeping the taper even up to the junction of the two sides by pegging or wedging the sides, proceed to nail on short lengths of 1 in. × 3/4 in., as indicated in Fig. 2, first going up the side lying uppermost, then turning over and

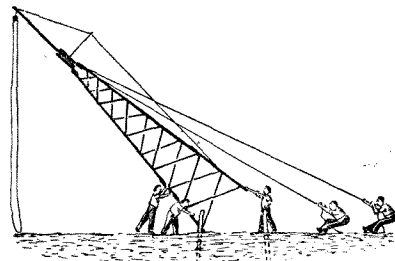

The mast should be pulled up in the manner shown.

doing the same on the other side, only this time spacing so that each length crosses the length on the other side in the middle. If a piece of wire is now twisted round each of these crossings, as in Fig. 3, it will add much to the strength and rigidity of the whole. The spacing was about 3 ft., but this is not important and can be adjusted within limits, though the angle marked "G" in Fig. 1 should not exceed 45 degrees.

The Strut

The strut "H" consists of a piece of 1 in. × 3/4 in. slating batten securely screwed across the broadest part of the junction and should protrude not less

than 4 ft. A wire stay is brought from the top of the mast through a strong staple in the end of the strut, and securely fastened to the back of the mast at "I," 6 ft. from the bottom. Two more stays should be attached, one each side at the junction at "A" "B." Do not forget to attach the insulator to top of mast, together with the running halliards. This insulator to my mind is much superior to the pulley block sold for this purpose. There is no danger of jamming, rusting or breakage, and a good egg insulator will stand an immense strain besides providing a perfectly smooth free running surface for the cord. I first used cord for the halliards, but after one experience of a break, which necessitated the lowering of the mast, I decided to substitute Electron wire, which is most satisfactory in every way, and also cheaper than a good cord.

Pegging

No hole has to be dug for the bottom of this mast, which should be erected edgewise to the pull of the aerial. To do so, drive two pegs of stout rough timber into the ground at the point where you wish the base to rest. Any old rough wood will do for these, provided they are not too thick. They should be driven to a depth of about 2 ft. with at least 3 ft. above the ground, and 4 ft. 4 in. (the outside measurements of the bottom of the mast) apart. Two more stout pegs should be driven in each side from 10 to 15 ft. from the base in a line with the rear-most leg as shown in Fig. 4. These are for the stays.

Raising the Mast

At least five persons should be commandeered to raise the mast, one at each side stay, two to raise from underneath and one at the end to guide the legs into position and keep the whole mast edgewise whilst raising. This is very necessary, otherwise, if it is raised flat, too great a strain is placed in the middle. Fig. 5 denotes the correct way of raising. When the mast is upright the two side stays should be temporarily made fast whilst the mast is adjusted between the two stout pegs prepared before, and a screw put in each side. Then finally tighten

up the stays seeing the mast is quite perpendicular, and put in two more screws each side at the bottom. You will be agreeably surprised at the rigidity of this construction and the ease with which you can keep your aerial

taut in the highest wind. The question of painting, etc., I leave to you. As mentioned before, this pole has stood for over a year in the fiercest of weather and has shown no sign of wear. It was not painted.

Table of Constants for Frequency of 10⁶ cycles per second

Most of the data published upon the subject of dielectric losses and power factors is disappointing, inasmuch as the frequency at which the tests are made is not sufficiently high.

We are, therefore, very interested in the figures given below, for which we are

indebted to the Proceedings of the Institute of Radio Engineers, showing the dielectric losses and power factors for different materials, the figures being obtained at a frequency of 1,000,000, corresponding to a wavelength of 300 metres.

It should be mentioned that, in the list given below, the materials Formica and Celeron both contain Bakelite as an essential component.

No.	Material.	Dielectric Constant.	Power Factor.
1	Hard Rubber	2.53	0.007
2	Celluloid	4.10	0.042
3	Formica	3.83	0.050
4	Mica	2.94	0.0004
5	Sulphur	3.03	0.006
6G	Glass	5.65	0.008
7	Petrite	5.34	>0.100
8	Bakelite Dilecto Gr. 20	3.86	0.057
9	Bakelite Dilecto Gr. 20	3.86	0.059
10	Hard Rubber	2.60	0.012
11	Vulcanised Hard Rubber	2.92	0.007
12	Hard Fibre (gray)	6.05	0.070
13	Hard Fibre (black)	5.26	0.052
14	Bakelite Dilecto	3.91	0.059
15	Formica (Grade M)	3.60	0.051
16	Radion (black)	3.22	0.017
17	Hard Rubber (2 XX)	2.66	0.011
18	Hard Rubber (40)	2.57	0.011
19	Hard Rubber (35 R)	2.79	0.008
20	Hard Rubber (7A)	2.56	0.014
21	Red Fibre	4.35	0.054
22	Bakelite	3.87	0.037
23	Leatheroid	4.27	0.048
25	Mahogany... ..	4.43	0.051
26	Celeron	4.12	0.049
27	Celeron	4.40	0.065
28	Celeron	3.73	0.057
29	Celeron	3.93	0.057
30	Fibroc	3.99	0.041
31	Bakelite No. 1	3.83	0.039
32	Bakelite No. 2	3.73	0.039
33	Bakelite No. 3	3.81	0.042
34	Bakelite No. 4	3.88	0.043
35	Bakelite No. 5	3.84	0.044
36	Bakelite No. 6	3.76	0.045
37	Vulcabeston No. 120	3.42	0.037
38	Vulcabeston No. 701	3.71	0.046
39	Vulcabeston No. 501	3.95	0.050

A Three-Valve Loud-Speaker Set for the Local Station

By JOHN W. BARBER

THE set to be described has been designed to fill the need for a handsome, all-enclosed receiver for family use, which may be operated by any

member of the family, and which will work a loud-speaker within ten miles or so of a Broadcasting station, in conjunction with an indoor aerial. The actual conditions in which the set was to work made the use of an outdoor aerial impossible, without the inclusion of about forty feet of "lead-in" from the aerial to the position where it was desired that the set should be.

Simplicity

The factor of simplicity was one of great importance, as the presence of children necessitated the removal from view of all that might invite curiosity, and it was therefore decided that everything should be mounted behind the panel, while the latter should be enclosed in a cabinet which was capable of being closed up completely when household cleaning operations were in progress.

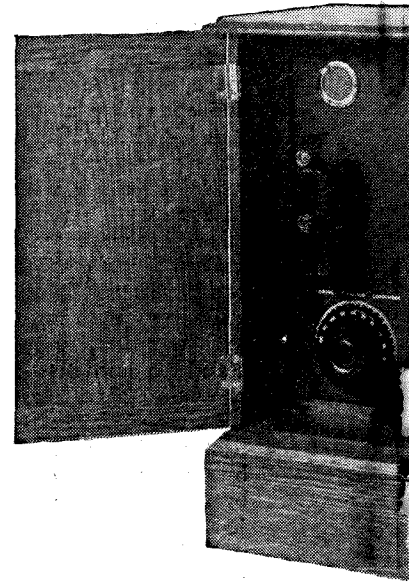

The coils and valves are contained considerably to its side.

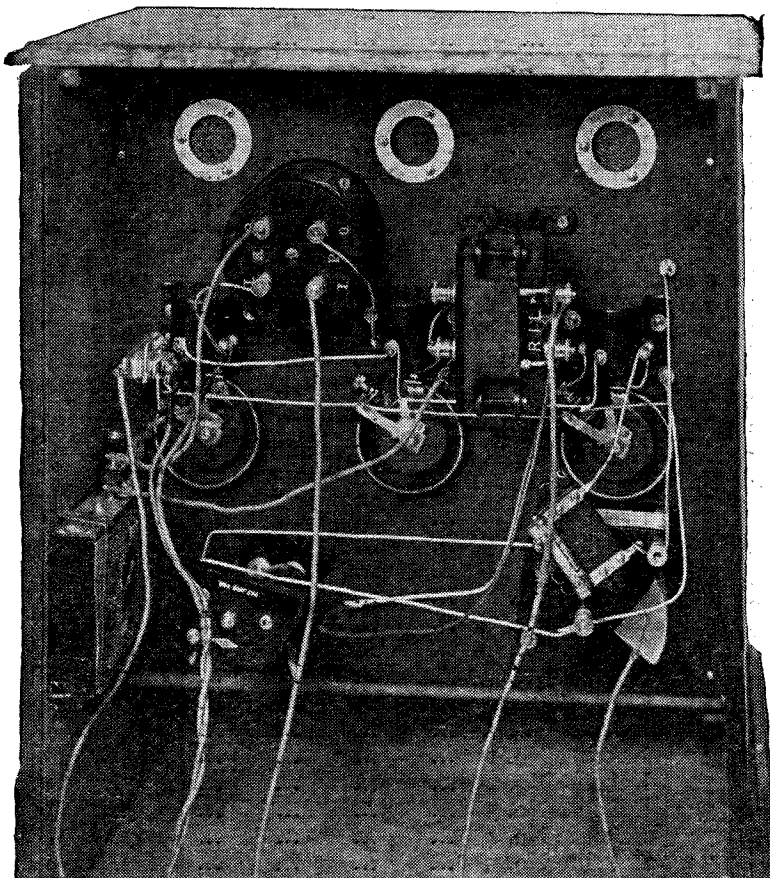

The wiring behind the panel is here seen. The coil-holder is in the bottom left hand corner.

The absence of any person with a knowledge of the subject necessitated the use of some automatic device for switching on and off, and it was finally decided that a plug and jack would be most suitable for this purpose, the choice falling upon a jack of the "single-filament" type, which, on the insertion of the plug, completes the connection from the accumulator to the filaments and places the loud-speaker in the anode circuit of the last valve.

Terminals

For the sake of simplicity it was decided that terminals should be dispensed with, the only exception being made in respect of aerial and earth, flexible leads being taken from the necessary points to high- and low-tension batteries respectively. The battery for grid bias is included in the cabinet itself, being secured in any convenient manner to the side of the woodwork.

The photographs show the receiver as finally decided upon. The aerial and earth terminals are seen on the left of the panel, at the bottom of which are the knobs controlling the aerial tuning condenser and reaction coup-

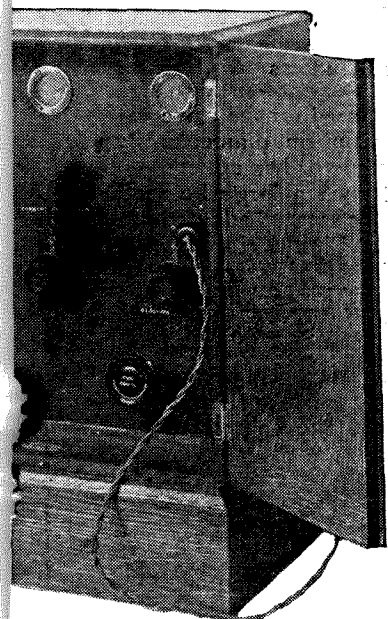

ned within the set, thus adding simple appearance.

diagram, and a separate drawing is given of this.

Components Required

For the benefit of those readers who may desire to duplicate this receiver, a list of the necessary parts is given below, and for readers' information the names of the various manufacturers are included. It is, of course, not essential that the actual parts specified should be used, any corresponding components of good make being suitable, but in-so-far as values are concerned, the reader is advised to follow these faithfully, in order that the results of the set may be duplicated.

One cabinet, totally enclosed type (Camco cabinet).

One ebonite panel, 12 in. x 12 in. x $\frac{1}{4}$ in. (Paragon).

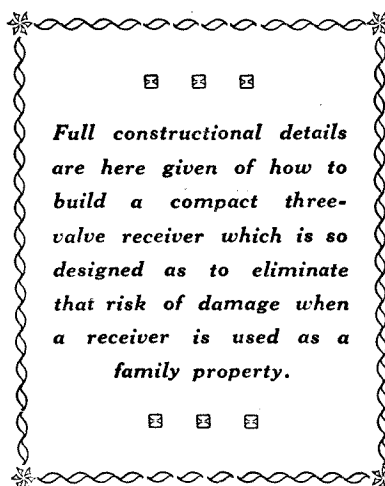

Full constructional details are here given of how to build a compact three-valve receiver which is so designed as to eliminate that risk of damage when a receiver is used as a family property.

Three valve holders, for back of panel mounting (Aermonic).

Three suitable rheostats, according to whether bright or

ling. The three filament resistances are seen above these controls, while the jack is situated between the resistances and the line of valve windows.

The Circuit

As will be seen from the diagram, the circuit is perfectly simple and straightforward, and as the receiver was designed for the special purpose referred to above, it was necessary that nothing should be included which would give any possibility of trouble by reason of complication. The incoming oscillations in the aerial circuit $L_1 C_1$ are rectified by the valve V_1 , by reason of the grid condenser C_2 and leak R_4 , reaction being introduced by coupling the coil L_2 to L_1 . The rectified signal is then passed through the primary winding of the transformer $T_1 T_2$, and the induced currents in the secondary are impressed upon the grid of the second valve. In a similar manner the valve V_3 is included in the circuit, and the loudspeaker is joined in the anode circuit of V_3 . For simplicity the connections to the jack have not been shown in the circuit

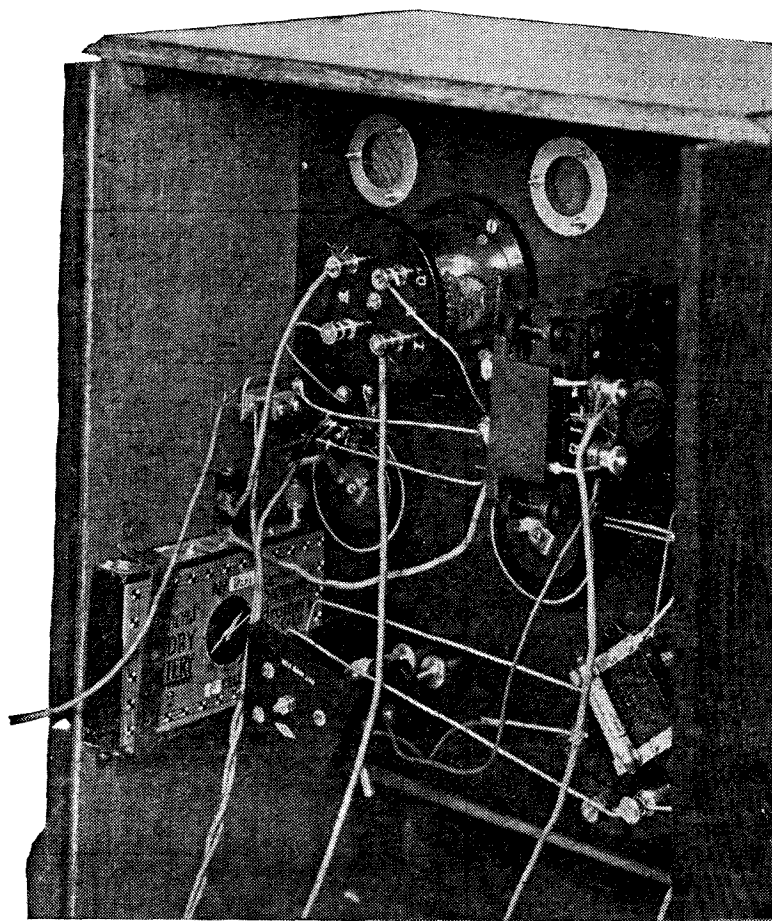

A photograph of the back of the receiver showing how the grid battery is mounted.

dull emitter valves are to be used. I have used Royal rheostats, supplied by R. A. Rothermel, Ltd.

Two suitable low-frequency transformers. I have used an R.I. and a "Silver Success," the

holes, i.e., the holes do not go right through the panel, thus preserving the neat appearance. If the constructor does not possess the necessary (4B.A.) tap, clearance holes may be drilled right

holders, although in this case the holes actually pierce the panel, the ends of the screws finishing flush with the surface.

Valve Windows

The holes required for the valve windows are 1 in. in diameter, and if the constructor has not the means to drill such a large hole a few notes on the method adopted may be of use. First a circle of the required diameter is scratched on the back of the panel with a pair of dividers. Another circle, $\frac{1}{8}$ in. less in diameter, is then scratched on, with the same centre. A number of $\frac{1}{4}$ -in. holes are then drilled, the centres of the holes being on the smaller circle, and as close together as possible. It is then an easy matter to remove the unwanted piece of ebonite by a light tap, after which the hole may be cleaned up by means of a half-round file.

When all holes have been drilled, it is a good plan to put on the panel transfers, as this may be a somewhat difficult matter after the components have been mounted up.

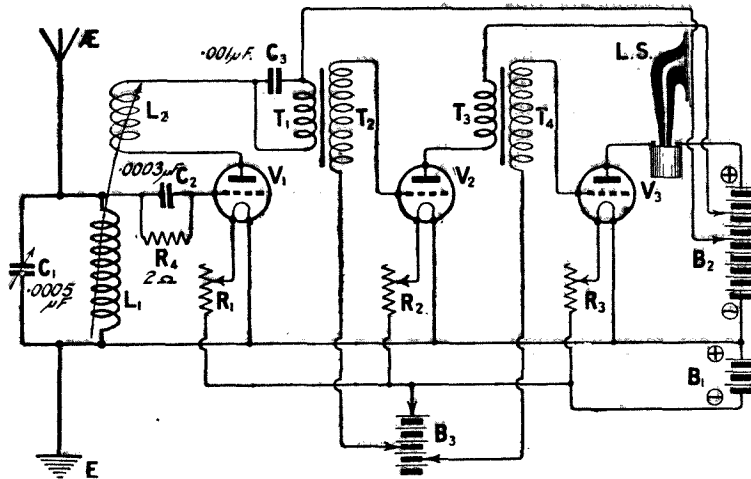

The circuit used in the receiver.

latter being designed for second stage amplification. Any two which will work well together may be used, and if you use other makes, be sure they will run well in "double-harness."

One coil holder, two-way, for back-of-panel mounting (Peto-Scott).

One variable condenser, .0005 μ F (Jackson Bros.).

One .0003 μ F fixed condenser and 2 ohms leak (Dubilier).

One .001 fixed condenser (Dubilier).

Two terminals, nickel plated.

Three nickel valve jacks (Bowyer-Lowe).

One single filament jack.

One plug.

Seven H.T. plugs, four red and three black.

Flexible wire, and No. 16 tinned copper for connections.

Constructional Details

The panel may be drilled in accordance with the drilling diagram, which shows the layout of those components which are visible on the front of the panel, and no difficulties are to be expected in this direction. The layout, as given, results in very short and convenient wiring, and should, if possible, be adhered to.

It may be pointed out here that the screws holding the transformers are tapped into "blind"

through the panel and countersunk on the front, countersunk head bolts then being used to secure the transformers in position. Similar remarks apply to the screw securing the valve-

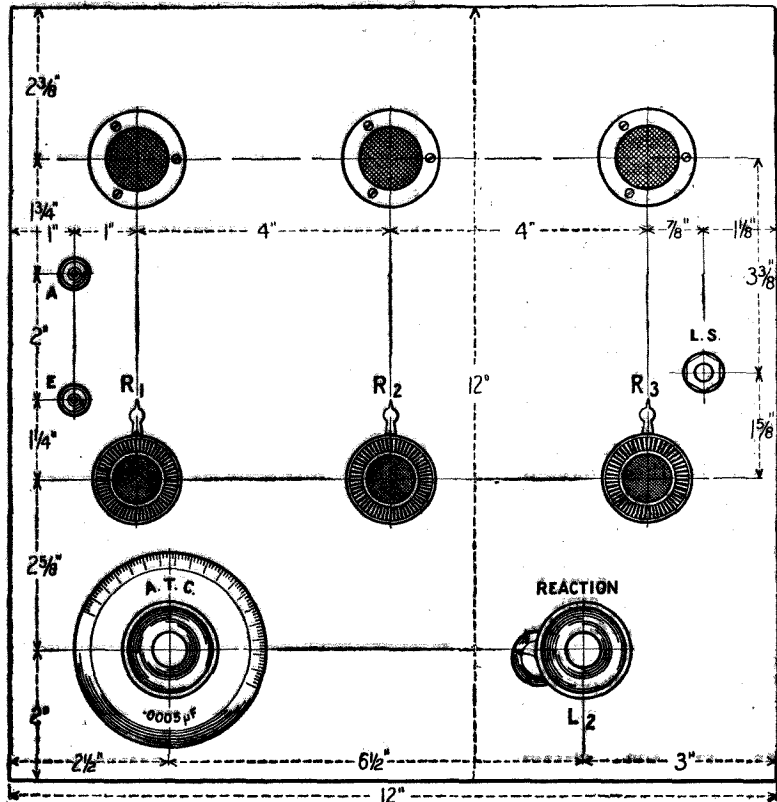

The layout of the panel showing dimensions. Blueprint No. 96a.

Wiring Up

The wiring of the receiver will be clear from the practical diagram of connections, and the photographs will help to show the planes of the various wires. It may be thought that the position of the transformers with respect to the valve holders would limit the size of valve that may be used. This is not the case, however, and I have inserted as large a valve as a T15 transmitting valve into each holder, without touching either transformer.

The connections to the transformers are best only for the actual makes used, and if others are employed it may be necessary to reverse the connections to the secondary winding. A little time spent in experimenting in this direction will be well repaid by the clearness of reproduction obtained.

Mounting the Panel in the Cabinet

When complete the panel is mounted in the cabinet by means of screws through the four holes shown in the drilling diagram, and when this has been done attention should be given to the

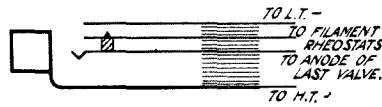

The connections to the jack.

grid battery, which may very conveniently be one of the 9-volt variety now obtainable. In this case I have used a "Meccano" strip, bent so as to form a bracket, as seen in the photographs. Connection is easily made to the battery by means of flexible leads from the negative

L.T. bus bar, which joins to the positive of the grid bias battery, and from the I.S. of the two transformers, which are connected to negative tappings.

The flexible leads to the high-tension battery are then to be bared at the ends and suitable plugs joined on, after which a test may be made on an aerial.

Accessories

The choice of valves is left entirely to the reader, but I advise the use of a power valve in the last stage. Almost any good make of receiving valve will be found suitable in the first and second sockets, and the maker's instructions as regards anode voltage should be carefully followed.

As regards coils, the size of aerial coil L1 will depend largely upon the aerial in use. On a short indoor aerial, a No. 50 coil is

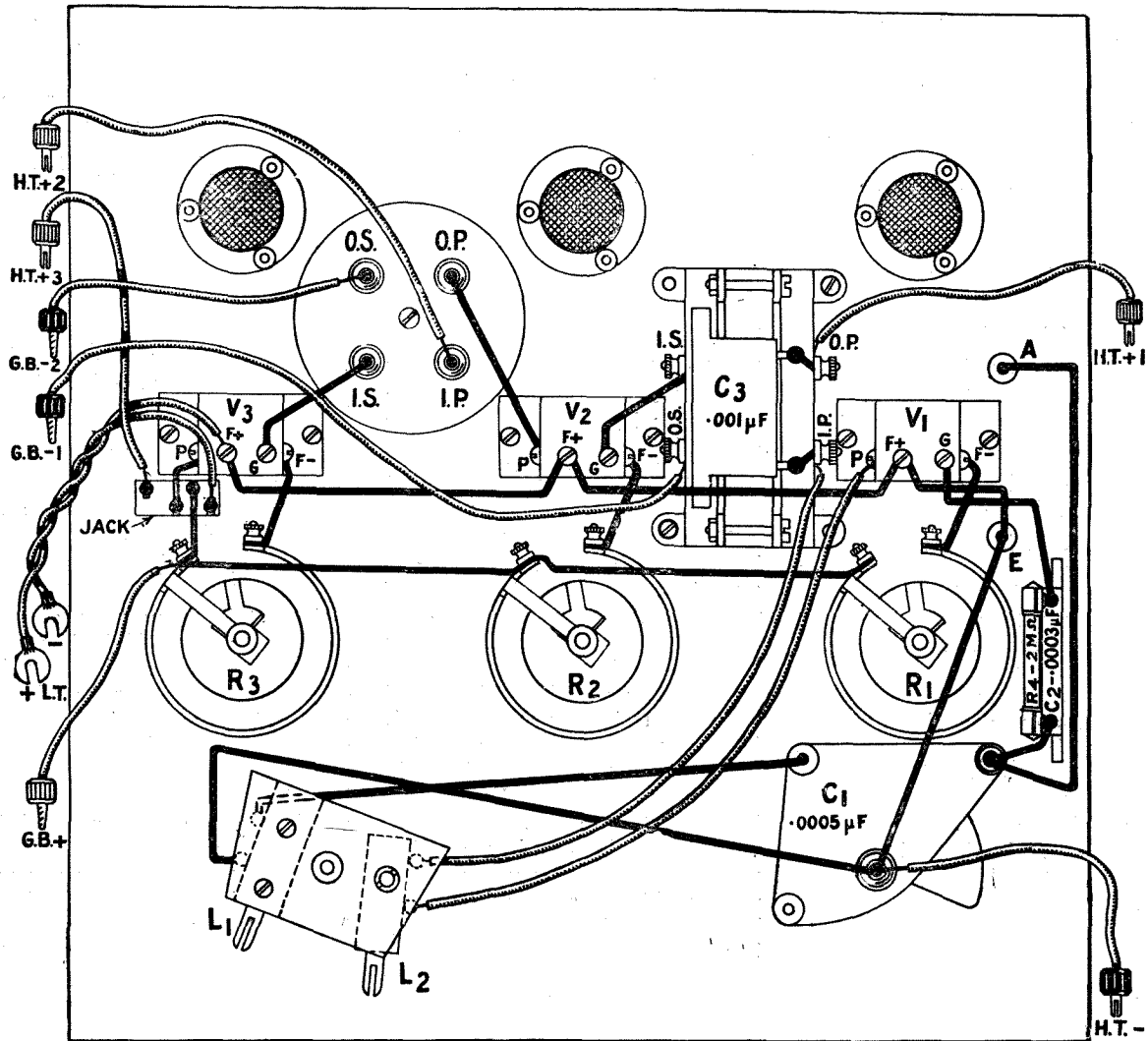

A practical wiring diagram of the receiver showing the connections made by the flexible leads. Blueprint No. 96b.

used in the aerial socket for 2LO, while a smaller coil, about a No. 35 or No. 40, is all that is necessary for reaction. For 5XX a No. 150 just brings the signals in at the top end of the condenser, a No. 100 being used for reaction.

Operation

The aerial and earth terminals are joined to the respective leads, and the tappings are joined to the high-tension battery according to the voltage required by each valve. The low-tension leads are joined to the accumulator, and the loud-speaker leads are connected to the plug, which may then be plugged into the jack. The variable condenser dial should then be slowly rotated, with the reaction coil well away from the aerial coil, and signals from the local station should be easily picked up. Reaction may be applied by tightening the coupling between the coils, when an increase in signal strength should result. If this is not the case reverse the leads to the moving socket. The actual value of grid bias will depend upon the anode voltage,

and the best value will be found by trial.

Results

On an outdoor aerial, six miles S.E. of 2LO, the music from that station was far too loud for comfort, and the set was immediately changed over to an indoor aerial, consisting of some rubber-covered flex from the aerial terminal to a hook on the wall holding a picture. On substituting a No. 50 coil for the No. 35 previously used, and retuning, excellent signals were obtained, being loud enough on a C.A.V. loud-speaker to be heard on the ground floor, the set itself being on the second floor.

Distant Stations

I have not tried for distant stations, as the receiver was not designed for such reception, but in favourable conditions one or two of the nearer stations should be heard.

The receiver forms an excellent "family" set, and operating as it does upon an indoor aerial, may be used to provide amusement for the "old folks" while the "wireless man" is experimenting on his outdoor aerial.

Starting Awkward Nuts and Screws

Everyone has had experience at some time or other of the exasperating business of starting a small nut on the shank of a screw in an almost inaccessible position in the wireless set. If the screw can be reached with the nut held in the pliers there is usually no room to turn them and even if there is the nut refuses to go on straight. Inspiration comes; one holds the nut in a pair of tweezers. It can be pushed down to the screw right enough, but the tweezers do not give you sufficient grip to enable you to turn it. Directly you try to do so the nut falls over to one side and refuses to go straight. In the end you may be forced to unsolder a portion of the wiring or to remove temporarily some component in order to get at the desired screw.

All this trouble may be avoided by making use of a tip so simple that you will wonder why you had not thought of it before.

Take a piece of screwed rod and see that the end is flat. Put the nut on to it, giving it two turns only. This will leave plenty of threads in the nut disengaged.

Awkward Screws

Now push the nut down on to its screw, get it straight, and turn it round with the point of the scriber. The action of screwing it on in this way also screws it off the rod, so that at the end of two turns it is well started and the rod may be removed. You must notice by the way that the rod must not be twisted in the process, or it will be screwed further into the nut.

This simple tip has another use also; it enables you without any trouble to start a nut from below on to the downward-pointing shank of a screw, a job which if attempted without it where there is little room would try the temper of the most patient of saints. In those cases

where we desire to put a screw into a component where there is little space, there is in consequence no room for the fingers to get in, or at any rate to be able to move so as to start the nut. Take a strip of sheet brass and close to one end of it fix a short screw of the right size. Place the nut on it with only two turns and place the nut against the inaccessible screw, using any convenient tool to give the nut the few necessary turns to make it start on the threads.

Fine Screws

Small fine screws, particularly if they are very short, are often very difficult indeed to start. The fingers seem somehow to be quite unable to hold them straight and turn them at the same time. Matters are made much easier if the tool outfit contains a screwdriver whose blade will wedge tightly into the cut in the screw's head, but as a rule one is not lucky enough to find any screwdriver that is a good enough fit. An extremely good way of dealing with recalcitrant small screws is as follows: Cut out a strip of stiff paper and prick in it close to one end a hole through which the screw will just pass. Push it through and use the paper as a handle. You will then have no difficulty in getting it to its proper place and holding it straight. When a screw does hold, the screwdriver will do all that is necessary to start it without further trouble. As soon as the screw has begun to go in remove the paper by pulling it.

Metal Screws

A metal screw may also be difficult to start if it has been necessary to shorten it by cutting off a portion of its screwed stem with a hacksaw. This can be obviated by tapering off the point with a fine file after the cutting has been done. But there is another very simple method for making matters easy. Before you start to cut the screw, run a nut on to it right up to its head. Then when your cut has been made unscrew the nut after the point has been trimmed up, and in coming off it will automatically put right any damaged portions of the thread.

Radio Notes and News

Four Stations for Greenland

THE Danish Government is proceeding with the construction of four stations for Greenland. Three are being built on the west coast, one at Julianehaab, one at Godthaab, and one at Godhavn, each placed five degrees of latitude apart. The fourth station, at Angmagsalik, is on the east coast, opposite the Godthaab station.

The Julianehaab station is being built to maintain communication with the Färoe Islands, which lie about 1,300 miles away; and when atmospheric conditions are favourable, they hope to reach as far as Copenhagen (2,200 miles). It is expected that all the stations will be completed before the end of the year.

Short Waves Heard in France

The radio section of a French newspaper announces about eight new stations from all parts of the world which are picked up regularly on wavelengths under 200 metres. Several of these are from America, but one from New South Wales, 2 XI, working on 27 metres, has particularly roused the interest of the amateurs. It is reported that this station comes through not quite as strongly as 1 XAM of America, on 45 metres.

French Radio Clubs Confederate

Radio Clubs of the Southwest of France have decided to unite in a confederation for the purpose of protecting the rights of the radio amateur. The Confederation which will include all the clubs of the South-west, will meet in council, in the name of the amateurs of that region, for the purpose of insuring freedom in radiotelephony, respect for the decree of November 23, 1923, which gave unrestricted rights to amateurs in experimentation, etc., and an absolute opposition to anything which might be tentative of a monopoly.

Paris Heard in China on One Valve

A new record in radio reception has been accomplished by a French amateur in Tonkin, China, according to advice received from an official source. It seems that all the transmissions

of the Eiffel Tower have been picked up by an experimenter in Baku to the north of Tonking, M. Barbier-Sant-Hilaire, with an apparatus containing a single valve. The concerts, and the other transmissions upon a wave-

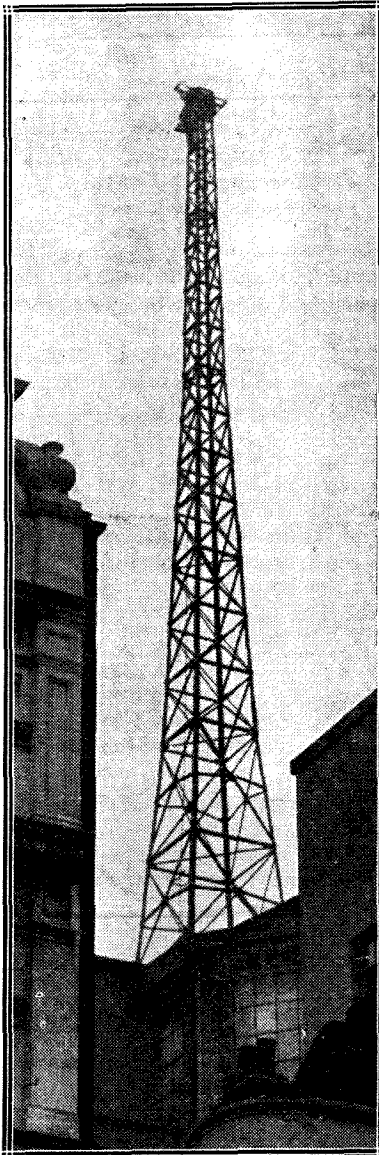

On and after February 14, 2LO will transmit from a new and improved aerial on the roof of Selfridge's, in Oxford Street. The aerial hitherto used has been that belonging to the Marconi Company on Marconi House, but owing to its proximity to the Air Ministry's aerial on Adastral House, with which it has interfered, its further use for broadcasting is prohibited. Our photograph shows the new mast on Selfridge's roof.

length of about 115 metres, reached him clearly even at such a great distance.

The transmissions were received more easily and clearly at day-break and at nightfall than at any other time. During the nights especially, the static was strong enough to spoil reception.

M. Barbier, in addition to these results, which have been registered, has also reported that he has received the special 100 metres transmissions of Poldhu, with great strength during the morning.

Doctor Saves Life by Wireless

A thrilling tale of a fight for life via radio in the middle of the Indian Ocean was told by the mail steamer *Angers* on its arrival at Marseilles. The *Angers* was making its way home from China, and was steaming between Colombo and Djibouti when a call for help came from the *Capitaine-Faure*, of the same company, saying that one of her officers was dangerously ill, and that no doctor was aboard. The doctor of the *Angers* was called, and a consultation made by radio, and for eight days while the two ships continued on their way the doctor of the *Angers* treated his invisible patient.

At the end of this time the patient was declared out of danger; and the doctor remarked as the affair ended, that this was the most remarkable cure he had ever made, since the patient's life hung not even on a wire.

Irish Broadcast Scheme Delayed

The plan to establish a State broadcasting service in Ireland, with main stations at Dublin and Cork, seems no nearer actuality than before. Under the Anglo-Irish treaty, radio stations for communication with places outside of Ireland cannot be established without consent from the British Government. Although the Bill establishing the service was passed by the Dail over a year ago, and the Posts and Telegraphs Department have completed their plans, the consent of the British Government has not been sought.

The scheme as outlined provides for two main stations at Dublin and Cork, with smaller stations at Waterford, Athlone and Limerick to be erected later. The costs of construction and maintenance are provided for by a license fee of one pound per annum which is imposed on all receiving sets.

Marking and Drilling Ebonite Panels

By H. BRAMFORD.

THERE is a right and a wrong way of doing most things, and this applies particularly to the marking out and drilling of ebonite panels. To execute this work in a professional manner is not so easy as it appears at first glance, and this article is intended to help those who are not familiar with work of this nature.

Points to Observe

Pencil lines should never be made upon a panel. A sharp steel scriber should be used and all lines thus marked should be made on the underside of the panel. It must be remembered

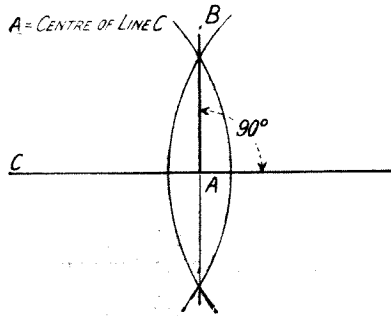

Fig. 1.—How to mark out a right-angle accurately.

that in marking out a panel from the back all the centre positions are exactly the reverse to that in which they would appear to be from the front, and an error is often prevented by sketching out the positions of the holes, or the layout of the panel, as seen from the top side.

Using the Scriber

In accurately marking out the panel, a certain amount of draughtsmanship is required, and a slight knowledge of geometry is useful. A steel rule engraved in inches, divided into 1/64th, 1/12th, and 1/10th, and also in millimetres, should be procured, as these are more accurate than the wooden variety, and they also act as an excellent straight edge for use in conjunction with the steel scriber. The scriber, if sharp, should be used lightly, as a faint line is all that is necessary.

Squaring Up

The panel to be drilled must first of all be perfectly square, otherwise all subsequent lines upon the panel will be inaccurate. Where a steel carpenter's square is available the difficulty is easily

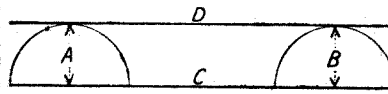

A & B = DESIRED DISTANCE OF PARALLEL LINES C & D
Fig. 2.—Indicating a method of drawing parallel lines at a given distance apart.

overcome, but a perfectly true paper, or cardboard square, may easily be made on the lines shown in Fig. 1. First draw a horizontal line (C) and strike a radius with a pair of compasses from each end, as shown. The radius may be of any dimension greater than half but less than the full length of the horizontal line. A vertical line (B) is then drawn to the points where the radii cross. This results in a perfect right angle between the line B and the line C. This same method may be used to bisect any given line without the use of a ruler.

Parallel Distances

Where two or more lines are desired to be perfectly parallel, the method shown in Fig. 2 is useful and simple. Two radii (A and B) are struck with a pair of compasses at the extremities of the line (C). The dimension of the radius should be equal to

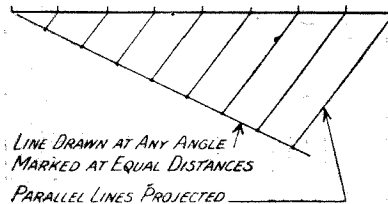

LINE DRAWN AT ANY ANGLE MARKED AT EQUAL DISTANCES PARALLEL LINES PROJECTED
Fig. 3.—Illustrating the method of dividing a line into a given number of equal parts.

the distance at which the parallel lines are desired to be from each other. The line (D), if drawn tangentially to the two semi-circles as indicated, will be parallel to the line C.

Equal Distances

It is often necessary to divide a given line into a number of equal distances having no known dimension. This is done as shown in Fig. 3. The horizontal line in the diagram is divided into eight equal parts in the following manner:—Draw a line at any angle to the horizontal line, as shown, mark off eight equal distances along this line with a pair of spring dividers. Join the last point to the other extremity of the horizontal line and by means of a rule and set square draw parallel lines from the other seven points. This results in the horizontal line being equally divided into eight parts. Any number of divisions are obtained in a similar manner.

Marking Out Circles

A circle of any given diameter is easily divided into two, three

A = RADIUS

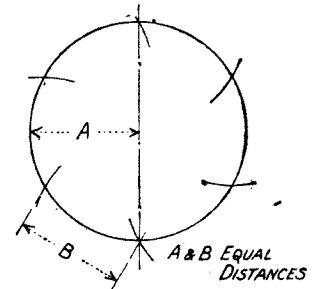

A & B EQUAL DISTANCES
Fig. 4.—Dividing the circumference of a circle into a number of approximately equal parts.

or six parts, as shown in Fig. 4. Having described the circle with a pair of compasses, place one point of the compass on the circumference of the circle and travel round as indicated, each division (B) thus made will be approximately 1/6th of the circumference.

Counter Sinking and Recessing

Counter sinking is done with a counter-sink bit. The panel hole is drilled first and the counter-sinking, which is self-centring, is the second operation. The depth of the counter sink may be controlled by attaching a depth gauge to the shank of the bit. In the case of recessed holes, the larger drill should be employed first. This drill will automatically centre the smaller drill; here again the depth gauge may be used.

Correspondence

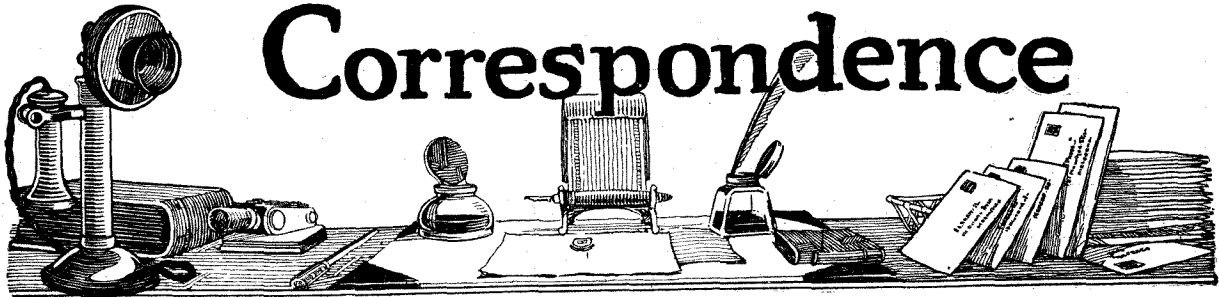

THE FIVE-VALVE SUPER-HETERODYNE RECEIVER

SIR,—With reference to your diagram for the Five-Valve Super-Heterodyne Receiver in *Wireless Weekly*, December 24, 1924, for which I am sure many experimenters of limited resources will thank you, I wish to inform you that I have wired the circuit up, and have got excellent results. Since our local station started, it has not been an easy matter for users of valve sets in the neighbourhood of Belfast to get transmissions, except well below 400 metres, without interference from 2BE, although I could get every station quite easily except 5SC without interference when using a straightforward, direct-coupled circuit, 1H.F., Det. and 1L.F. Recently I com-

menced to operate the Supersonic Heterodyne receiver, and had 5SC on a loud-speaker when using two stages of L.F. amplification; this is, undoubtedly, the ideal type of receiver, and I am of the opinion that a seven- or eight-valve receiver would satisfy the most ambitious experimenter. The selectivity of the five-valve receiver is very high, and to those who are suffering from interference from a near-by station I would recommend them to build the Five-Valve Supersonic Receiver.

My success was due to having carefully read your excellent articles on "Supersonic Heterodyne Reception," over two years' experimenting combined with a course of theory and practice on wireless subjects at our local municipal col-

lege of technology. In addition to these, I have carefully studied all articles of a theoretical nature which have appeared in *Wireless Weekly* and *Modern Wireless*, and which are invaluable to all serious experimenters in wireless. I might just mention in passing that I have every copy of *Wireless Weekly* and *Modern Wireless* from the first number, also *The Wireless Constructor*.—Yours faithfully,
Belfast. WM. C. HADDICK.

THE HILVERSUM STATION

SIR,—I enclose a letter which I have just received from the Hilversum station. Some of the information may be of interest to readers of Radio Press publications.—Yours faithfully,
Sevenoaks. Z. KIRKPATRICK.

LOUD SPEAKERS		
STANDARD 2000 ohms	£5	0 0
" 4000 "	£5	10 0
" 120 "	£4	15 0
JUNIOR 2000 "	£2	15 0
Black Crystalline or Black Satin Enamel		
TOM-TIT 2000 ohms	30/-	
Black Crystalline or Bright Stove Enamel		

C.A.V.

GARRY AND VOLME

OVER THIRTY YEARS ELECTRICAL EXPERIENCE

C.A. Vandervell & Co., Ltd.
ACTON VALE, LONDON, W. 3.
Members of the N.A.R.M.A.T.

IMMEDIATE DELIVERY

SIR,—We are very indebted to you for writing to us and giving us useful information concerning your reception of our wireless transmission, and we hope the information stated here will be of some interest to you.

No definite scheme of broadcasting such as you have in England has ever been founded in this country.

Either as advertisement or hobby a few Dutch manufacturers or amateurs have transmitted wireless music, but one is bound to state that owing to the very high expense involved in real broadcasting, the thousands of Dutch enthusiastic amateurs have had little of that high-grade sure entertainment which you enjoy. We have great admiration for the manner the English have attacked the difficult technical and more difficult financial problems involved in broadcasting.

About a year ago, as manufacturers of wireless apparatus, we constructed a small broadcasting transmitter and commenced a very modest Sunday evening transmission. With our limited means we gradually improved our transmitter in power and quality, even to the extent of being able to relay con-

certs and opera transmitted along telephone lines.

After a few months we received letters from thousands of listeners-in who appeared to be regularly enjoying our Sunday concerts.

But the commercial gain did not justify further expense, and to enable us to "carry-on" we appealed for help to our enthusiastic unseen audience. As a result we were able to extend our transmission by one hour per week for entertaining children and by two hours per week for transmitting lectures and music. We hope to continue our programmes until properly organised broadcasting exists in this country.

Our wavelength is 1,050 metres. Hilversum is situated about 20 miles south-east of Amsterdam. Our transmitter has an output about equal to that of the B.B.C. stations.

The aerial is only 60 ft. in height. We hope to improve this. The microphone is similar to the Marconi Magnetic Microphone, and the control power valve is water-cooled. Our hours of transmission at present are as follows:—

Sundays, 7.40—10.10. Concert.

Fridays, 8.40—10.10. Lecture and concert.

Mondays, 6.55—8.10. Children's hour (temporarily).

(British Summer Time.)

We hope that you will inform your friends and the local Press of our existence and assure them that any report of our English listeners-in is highly appreciated and will be answered by return of post.—Yours faithfully,

HILVERSUMSCHE DRAADLOOZE
OMROEP.

Hilversum.

THE ALL-CONCERT DE LUXE

SIR,—I am a regular reader of your three valuable journals and have constructed some of your circuits, the last being the All-Concert de Luxe, in which I added an additional note magnifier. I find that this set works a loud-speaker on London perfectly. I have also had all other stations with ease on two pairs of 'phones; Bournemouth, Birmingham, Cardiff, Chelmsford and Radiola being loud-speaker strength. Of the other foreign stations I have received Madrid, Copenhagen, Petit Parisien, Vox Haus, Frankfort, Lausanne and Ecole Sup. des Postes.—Yours

W. G. HANKS.

Walthamstow.

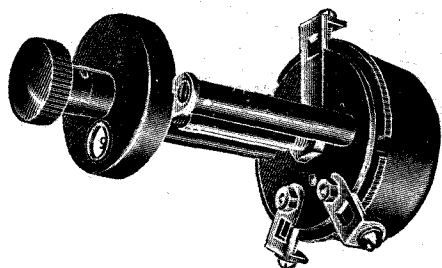

A high - resistance Potentiometer —is best

It is best because high resistance value and consequent low current consumption makes the useful life of the grid cells far longer than when a low resistance potentiometer is used.

And this Igranic 30,000 ohm Potentiometer is best because it gives very smooth and even adjustment, ensuring critical variation of the grid potential. Silent in operation, it is sturdily built, and with its unique indicating dial will give a neat finish to your panel. Single hole fixing.

Price, 8s. 6d.

All reputable dealers stock. Write for List V 48

- IGRANIC RADIO DEVICES** include:
- Honeycomb Coils
 - Fixed Condensers
 - Filament Rheostats
 - Intervalve Transformers
 - Variometers
 - Vario-couplers
 - Bi-plug Coil Holders
 - Tri-plug Coil Holders
 - Battery Potentiometers
 - Vernier Friction Pencils, etc., etc.
- All carry a six months' guarantee.



149, Queen Victoria Street, LONDON. Works: BEDFORD
Branches: BIRMINGHAM, CARDIFF, GLASGOW, LEEDS, MANCHESTER, NEWCASTLE

Quality RADIO DUPLEX BASKET COILS.

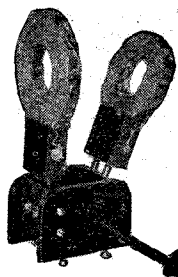

The most efficient inductance coil made for short waves, mounted on standard plugs. No wax or varnish used.

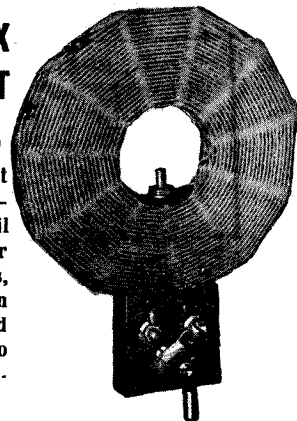

Number	Mounted	Mounted with Reaction Reverse Switch	Unmounted.	Number
25	1 6	3 0	0 9	25
35	1 9	3 3	1 0	35
50	2 0	3 6	1 3	50
75	2 3	3 9	1 9	75
100	2 9	4 3	2 3	100
150	3 0	4 6	2 6	150
175	3 6	5 0	2 9	175
200	3 9	5 3	3 0	200

Postage: 3d. each. Set of eight coils post free.

If your dealer cannot supply, we send post free if you mention his name and address.

GOSWELL ENGINEERING CO., LTD.

12a, PENTONVILLE ROAD, LONDON, N.1.

Liberal Trade Terms.

LIST FREE.

'Phone: North 3051.



Conducted by A. D. COWPER, M.Sc., Staff Editor.

Ediswan "Televox" Loud Speaker

Messrs. Edison Swan Electric Co., Ltd., have submitted for trial one of their large and stately pattern of loud-speakers, the "Televox." This stands nearly 2 ft. high, with an ample curved, wide-mouthed trumpet, and is finished in an elegant style in dull bronze. The resistance is 2,000 ohms.

A peculiar type of adjustment is provided for the magnets; the upper part of the base, carrying the diaphragm, screws on a large-diameter thread on the lower part, in which the magnets are fixed, a locking ring fixing this adjustment when made. This does not appeal to us as being a very mechanical device, or one consistent with the general style of this large and expensive instrument; there was a

noticeable amount of side play and back lash in the screw threads in the instrument tested, and the act of tightening the locking ring generally spoilt a careful adjustment. A peculiar device is incorporated in the form of a "modulator," a sliding keeper which is moved by a knob in the side of the base more or less into the magnetic field of the permanent magnet, thus weakening the pull at will. It is difficult to see the point of this device, which in practice simply has the effect of producing a muffled tone, as adjustment of volume can be so readily made in practice by slightly detuning the receiver without introducing distortion. We fear that in practice with this complex double adjustment in inexpert hands many instruments are likely to be

operated in an unfavourable setting, despite the carefully printed instructions of the makers for this operation.

On trial in actual reception, a favourable feature was immediately apparent, in that the tone, unlike that of some pretentious and expensive instruments, had not that hollow, "low-pitched" effect mis-called "mellowness," so that better justice was done to the higher-toned instruments in a band, and to a high soprano voice than is usual. The sibilants were not so completely lost as is customary when a large diaphragm capable of handling much energy is used. This instrument could handle, without diaphragm rattle, the large volume given by power amplification of 5XX at a moderate range far too loud to

AVOID.....OBTAIN
DISTORTION— SELECTIVITY—

Insist on having

**"TANGENT"
FITMENTS—**

"TANGENT" TUNING COILS

Covering wavelengths from 250 to 9,500.

"TANGENT" LOUD SPEAKERS

"Concert Model," "Tangent Tall Boy" & "Baby Tangent."

"TANGENT" L.F. TRANSFORMERS

Large and small.

"TANGENT" "DISCOL" H.F. TRANSFORMERS

All wavelengths from 80 to 4,000.

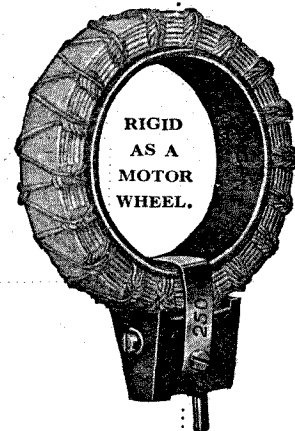

Obtainable from all good dealers—but in case of difficulty, write us.

GENT & CO. LTD. Est. 1872.
Faraday Works, LEICESTER

London:—25, Victoria St., S.W.1.
Newcastle-on-Tyne:—Tangent House, Blackett St.

tolerate in a private room. That sensitiveness has not been sacrificed to power can be judged from the fact that it was an easy matter, on a really good country aerial and with an efficient detector and a L.F. receiver using reaction, to tune in KDKA about midnight on the upper wave with this loud-speaker in another room across a hall from the receiver without the use of headphones at all. Both KDKA and later WBZ filled the house on this equipment, subject, of course, to the usual periodic fading and local oscillation.

We would like particularly to commend the external appearance and finish of this instrument. The best comment is perhaps that, although so large and powerful, it is inconspicuous when standing on a bureau in a refined drawing room.

"Trolite" Panel

Reference has been made recently in these columns to tests on samples of "Trolite" insulating material, a cellulose product. A number of different moulded objects, etc., of various colours, had been submitted for our comment; we are now in receipt of a sample of the finished "Trolite" panel, in the form of a large panel of 1/4 in. material in a mottled black and red wood-grain effect, of pleasing appearance. One

side of the panel is highly polished.

The working qualities of this substance have already been recorded; the surface insulating properties, on the highly-polished face, were subjected to a severe D.C. test, and showed no sign of leakage. The formal report from the National Physical Laboratory shows that the material has both exceedingly satisfactory dielectric strength and high resistivity after exposure to a moist atmosphere—a crucial point, as modern research indicates that H.F. losses in dielectrics can be traced largely to the presence of contained or absorbed moisture—and a remarkably low-power factor on 800 cycle A.C. The power-factor on high radio-frequencies is, of course, more relevant, but this low-frequency result should indicate a favourable behaviour at higher frequencies.

We understand that the material is supplied in several grades for various purposes, moulding and machining, etc., and in a variety of colours. Particulars are given of a number of standard types of knobs and fittings for radio work. The price is notably below that of ebonite. From our experience with these samples, we can certainly recommend this material, not only as an inexpensive substitute for ebonite, but as possessing distinct

qualities of its own which should be invaluable in radio work.

Sterling Headphones

Messrs. Sterling Telephone Co., Ltd., have sent for practical test a pair of 4,000 ohms head-telephones. These have a high finish in bright metal, and are of moderate weight. The usual double-hinged band is fitted with milled lock-nuts, and has in addition to the hinge adjustment a slotted arm adjustment for size. A generously-long cord of twisted flex is provided, and the finish and workmanship are of a high order.

In sensitiveness the 'phones compared favourably with various other types. The matter of comfort to the wearer, however, does not appear to have received very serious consideration by the manufacturers of this head-set, although to those who are compelled, at the present stage of advancement of the popular art, to wear headphones for several hours continuously every day in order to receive the programmes, the matter of continued comfort and ready exclusion of external noises by close-fitting ear-pieces which yet do not grip the ears in a painful manner after half an hour or so, is of quite as great importance as a beautiful finish or excessive sensitivity.

THE DIFFERENCE FINE TUNING makes to long distance reception

While the potential signal strength of any receiver may be good, large tuning condensers fail to balance circuits into resonance, so that the receiver cannot function at its best. With the use of large tuning condensers—since they do not allow delicate movement—tuning is never accurate. The advantages of circuits with razor-sharp tuning are therefore never used to their utmost capacity. But really accurate and delicate tuning is within the reach of every experimenter. Do not use a Vernier in association with the large condenser. Fit an independent vernier—it gives finer tuning. The COLVERN (max. cap. 0.00014 mfd.) will make your tuning razor sharp, enable you to build selective receivers and will demonstrate that your set is more sensitive to perfect balance than you have yet experienced.

As used by Percy W. Harris in the "Anvo-American Receiver," described in the February issue of the "Wireless Constructor."

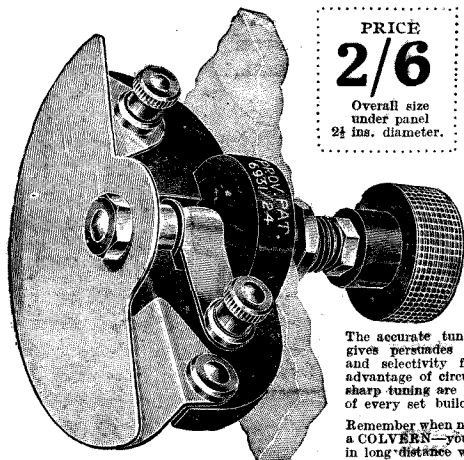

PRICE
2/6
Overall size under panel 2 1/2 ins. diameter.

COLVERN GENERAL PURPOSE VERNIER
—for the final balancing of TUNED CIRCUITS

The accurate tuning which the COLVERN gives preserves the utmost range, power and selectivity from your receiver. The advantage of circuits designed to give razor-sharp tuning are therefore within the reach of every set builder.

Remember when next at your dealers purchase a COLVERN—you cannot hope for efficiency in long distance work without it!

If your local dealer cannot supply, kindly send his name and address when ordering.
COLLINSON'S PRECISION SCREW CO., LTD.,
MACDONALD ROAD, WALTHAMSTOW - LONDON, E.17.

Telephone—WALTHAMSTOW 532.

Barclays 680

RICHARDSON'S NON-DIRECTIONAL PERFEX AERIAL
PATENT NO. 21657. ALSO PROTECTED ABROAD.

—PREVIOUSLY KNOWN AS THE "VERTEX"—marks a great advance in aerial construction. During the last 18 months it has been adopted after actual comparison by leading amateurs all over the country in preference to the old-fashioned P.M.G. type aerial. The PERFEX Aerial will improve your reception in every way, irrespective of the type of wire you have in your present aerial.

THE "PERFEX" OUTDOOR AERIAL
shown on the left will increase range, volume, purity and selectivity, and obviate interference from passing electric trams or trains. With one mast only, its compact form enables it to be erected anywhere, irrespective of space. Complete with downlead ready for attaching to mast:—
20 ins. diameter, 58/6 36 ins. diameter, 75/-

THE "PERFEX" LIGHTSHADE AERIAL
as illustrated, is a non-directional Indoor Aerial in the form of a handsome silk-covered Lightshade, for which it can also be used. The following ranges are obtainable on Phones with a good 2-valve set, or on a Loud Speaker with a 4-valve set:

6 feet above set	..	20 miles
15 feet " " "	..	75 "
25 feet " " "	..	175 "

Complete, as illustrated, with fittings for suspension **78/6**
With Silk Covered Diaphragm for indirect lighting **85/-**

Agents Wanted in Districts not yet Represented.
Can be obtained from all Wireless Dealers or direct from the Patentees and Manufacturers:

WIRELESS APPARATUS, LTD., 35, PANTON STREET, Haymarket, London, S.W.1.

D.P.D.T. Switch for Panel Mounting

Messrs. Lissen, Ltd., have sent for our examination a new type of "push-pull" single-hole-fixing switch of their make. This is a double-pole double-throw instrument, of exceedingly compact design and small dimensions, occupying a space represented by a circle of about 1½-in. diameter, with a depth of 2⅜ in. beneath the panel.

The switch is operated by a small neat knob on a spindle projecting through the usual screwed bush, and having a vertical movement of about 5-16 in.; a spring catch operating with a reassuring click locks this spindle in either position.

The six electrical connections necessary for a D.P.D.T. switch are made by soldering tags attached to small screws arranged round an ebonite collar which will come immediately beneath the panel when the instrument is mounted in place; then *via* stiff spring contact-fingers to metal contact-sleeves on the ebonite plunger which forms the moving element in this switch. The contact was found, on trial, to be certain and noiseless, and the switch operated smoothly. The insulation resistance was excellent in a severe D.C. high-voltage test. For various purposes on the low-frequency side of a receiver, and, in

cases where a few $\mu\mu\text{F}$ of added casual capacity are of no moment on the high-frequency side also, this compact switch (of fairly low capacity) can be recommended with every confidence. The finish and workmanship are of the highest class.

"Tungstalite" Crystal

A sample of their Blue Label crystal has been submitted by Messrs. Tungstalite, Ltd. This is supplied in sealed boxes, and is of the coarsely-granular description, being quite irregular in appearance and showing dull grey portions. On test, it showed a fair proportion of sensitive spots, which gave quantitatively the usual rectification efficiency of a good galena, but quite a number of settings gave negative results. On breaking open the rough crystal lump similar results were obtained.

B.T.H. Headphones

Messrs. British Thomson-Houston Co., Ltd., have submitted for test a pair of their latest type headphones of the high-resistance type. The constructional details of these 'phones have been given *in extenso* in an article in *Wireless Weekly*, Vol. 5, No. 7 (December 3), so that only practical tests will be referred to here, beyond remarking

on the attractive appearance of the brown finish of these headphones and their light weight.

In comfort they showed a marked improvement on many types on the market, although the ear-pieces appeared rather small to one accustomed to the larger variety. On trial in reception of very faint signals, the power of these small ear-pieces to exclude undesirable external noises made rather difficult any close comparison of sensitivity. In reception of fairly loud signals, such as local broadcasting at 35 miles on a good crystal equipment, they appeared to be on a par in sensitiveness with an excellent standard pair, by repeated and careful comparison with either ear in rapid exchanges, and in valve reception there was nothing to choose between them in this matter. The tone was natural.

The head-piece was of a convenient and sensible order, with no projections to tear the hair, and with a ready frictional adjustment for size. Ample cords were provided with the 'phones.

Combined Low-Capacity Valve-Holder and Grid-leak Holder

From Messrs. Read & Morris comes a sample of a valve-holder for panel-mounting by a single central screw, in which some pains

The CHASEWAY VARIABLE GRID LEAK

·001 to 20 megohms

A REALLY RELIABLE GRID LEAK AT LAST!

4/-

This is the greatest advance in grid leak manufacture yet made. *Reliable for all time* and gives extraordinary results in sensitivity and range. One hole fixing and can be easily attached to replace the old fashioned types. Totally different from and superior to anything else on the market.

The "CHASEWAY" EVERSET CRYSTAL DETECTOR
No extravagant claims are made for this totally enclosed permanent Detector, but it really has extraordinary power and banishes the bane of the Catwhisker. No attention is required, not affected by atmosphere and can be fixed on or under panel.

"CHASEWAY" Products are tested before leaving our Works.

2/6



Prov. Patents.

Any up-to-date Dealer stocks these lines, but send direct if any difficulty in obtaining locally.

Catalogue of "Chaseway" Novel Necessities free on receipt of stamp.

CHASE ELECTRICAL Mfg. Co., Ltd.
184w, Fleet Street, London, E.C.4. Phone Central 1539

TRADE ENQUIRIES INVITED. V.P.



They make Every Set a Better Set

There is no guesswork about the Bowyer-Lowe Square Law Condenser. Every claim made for it can be demonstrated by any experimenter who will test it.

Put Bowyer-Lowe Condensers into your sets and they will possess greater wavelength range, selectivity and total purity than would otherwise be possible—because only by the Bowyer-Lowe way can condensers be made to

give the square law effect with reduced losses and a greatly increased capacity ratio. That is electrical logic.

You can substitute these condensers for those of the ordinary type. They are NO larger. Make the exchange in your receiver to-day and note the big improvement.

Write for our New Price List containing full particulars. Enclose 1½d. stamp for postage.

Bowyer-Lowe Tested Radio Components

BOWYER-LOWE Co., Ltd., LETCHWORTH.

have been taken to reduce the capacity between the elements by making the connections to the outside of each leg-socket by small screws tapped into the latter, and by using the minimum of ebonite for holding the whole thing together. Actually the dielectric used is only $\frac{3}{8}$ in. thick by $1\frac{1}{4}$ in. square. Soldering tags projecting out radially provide for electrical connections. On the grid side, however, in addition to the soldering tag, a small bar of ebonite is provided which has clips for carrying the usual tubular type of fixed grid-leak in a horizontal position. Another small soldering tag is provided for the leak L.T. battery connection. The whole forms a very compact unit, which will certainly offer an appreciably lower capacity between the sockets than a solid ebonite socket of the usual type. For home-constructional work the unit should have convenient applications. The insulation-resistance, on high D.C. voltage test, proved adequate for all ordinary purposes, and the fitting is well and sturdily made.

Basket-Coil Holders

A neat form of plug-in coil-holder for basket-coils, providing in addition for variable coupling by a pivoting action by hinges on the

plug itself, has been submitted for test by Ledion, Ltd.

In this, an ordinary plug-and-socket fitting of small but of standard spacing size is provided; on this are pivoted two light rubber-covered swinging arms, which in turn carry at their extremities an ebonite rod that can be slipped diagonally through the gaps between the wires in an ordinary basket-coil, electrical connections being made by very small terminal nuts on the ends of the arms. Evidently the rod is intended to be removed from the arms in order to slip it through the coil, and the former is then secured afresh on the arms by means of these same small nuts. The arms have a radius of $2\frac{1}{2}$ in., and are bent so as to allow of close coupling of two coils face to face. The rod is about $3\frac{1}{2}$ in. long; evidently coils of larger diameter can be carried, provided that they are not too heavy for the somewhat slender construction. For experimental work with small basket-coils, this device should have useful applications. The insulation-resistance of the coil plugs proved adequate, on test.

"O.V." Portable Aerial

We have received from Messrs. Cable Electrical Supplies a sample of the "O.V." portable aerial.

This consists of a multi-strand or "sausage" aerial of small size, made up of eight cotton-covered wires of small gauge some 10 ft. in length, separated by three wooden ring-spacers of 1-in. diameter, and provided with insulated loops at each end for suspending it; a terminal is provided at one end for the lead to the set. The whole will evidently roll up into a parcel which can be carried in the pocket.

This was tested under the kind of conditions likely to prevail when such a device is utilised in practice, i.e., as an indoor aerial on an upper floor a few miles from the local station (2LO). A good gas-pipe earth was used, and a low-loss thick-wire air-core tuning inductance with very small parallel tuning capacity. Direct comparison was made with a single No. 20 d.c.c. wire of equal length and arranged in exactly the same manner across the room near the ceiling, by rapid switching and repeated careful aural observation of an approximate quantitative type. The same good setting of an excellent stable galena crystal was used.

Under these conditions loud signals were obtained; but there was scarcely any difference to be noticed between the "O.V." sausage aerial and the single No. 20 wire.



EXPERIMENTS with wireless circuits depend upon the ease with which wiring can be interchanged. Wires wrapped round ordinary terminals cause loss of power. Soldered connections weaken with constant breaking down. But Newey Snap Terminals ensure vibrationless contact and can be connected up or broken down with the finger and thumb of one hand. As many headphones as your set has power to fill can be connected up on their original setting with Newey Snap Terminals.

CONTENTS.

- 8 Terminal Studs, 6 Multi-Connectors, 4 Coloured Connectors, 8 Discs (Black, Red and Blue), Phones + Phones - High Tension + Low Tension + Earth Aerial
- Phones - Low Tension - Low Tension -

Complete with instructions. PRICE, 2/-

ASK YOUR NEAREST DEALER TO SUPPLY





PRICE
2/6

Prov. Pat. No. 19428/24.

The Value of Fine Tuning

is being more and more appreciated particularly when one buys the

MICROHM VERNIER TYPE VARIABLE CONDENSER

There are no less than 24 turns to give the "MICROHM" fine tuning adjustment.

Suitable for use as a stabiliser in "NEUTRODYNE" circuits.

May be used in parallel with an ordinary condenser, giving exceptionally fine tuning adjustment.

Maximum capacity .00001 mfd.
Minimum negligible.
One $\frac{1}{4}$ " hole fixing.

A Precision instrument designed on scientific lines.



MICROHM ENGINEERING CO.,
Varsity Works, College St., London, E.9. Phone: Clissold 2887

Information Department

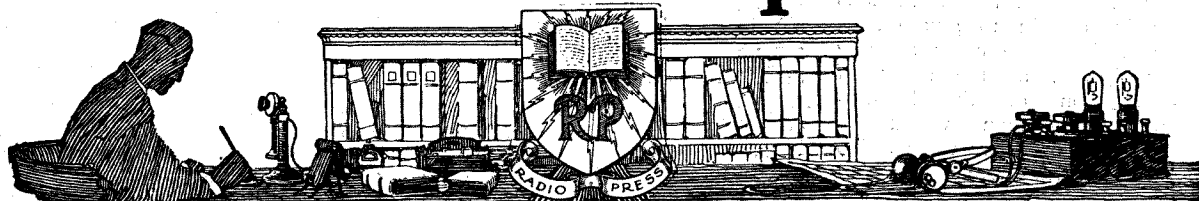

SUPPLIED BY RADIO PRESS SERVICE DEPT., LTD.

C. C. H. (EALING) has built a two-slider crystal set which has a small variable condenser connected across that portion of the coil which acts as the secondary. He experiences a good deal of difficulty in manipulating the two sliders, and asks for the correct method of doing this.

In a set in which the lead from the aerial is brought to one end of the coil, the earth lead to one of the sliders, and the "lower" end of the secondary circuit is connected to the other slider, the procedure is as follows:—Assuming that the crystal detector has been adjusted to a sensitive spot, the secondary condenser should be adjusted to a small value and the two sliders pushed up to the minimum end.

They can then be gradually brought along the coil, opposite to one another, until signals are picked up. The secondary slider should then be left in position, while the earth connection slider is moved in either direction until the loudest signals are obtained. Having found the best point, let us proceed to vary the secondary slider and the secondary variable condenser, aiming at as large an inductance and as small a condenser value as will give us the desired resonance with the received signals. After having accurately tuned the secondary circuit, a slight readjustment of the primary slider may improve results.

G. P. (GLASGOW) has constructed a six-valve set on the same

lines as the four-valve Family set, but with the addition of one H.F. and one L.F. valve. He finds that the results are not at all satisfactory and that when he is tuning in the local station he is unable to use five valves and that the distortion on the last stage is very bad indeed. He encloses a switching arrangement of the three note magnifiers and also of the H.F. valves. He finds he is unable to successfully use the extra H.F. valve and wishes to know how to improve the circuit.

The modifications and additions which have been made to the four-valve family set are such that we are surprised that our reader has obtained any results at all rather

HAWK COILS

MAXIMUM

Efficiency

Strength

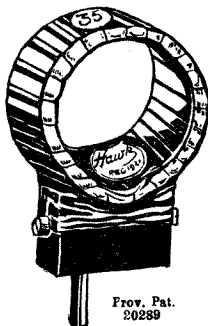

Prov. Pat. 20289

WATERPROOF

MINIMUM

Capacity
Damping Effects
Resistance

Prices below

Coil	Wave Length using '001 Variable Condenser in Parallel		PRICE.
	MAXIMUM	MINIMUM	
13	—	—	2/-
25	395	190	2/4
30	435	240	2/4
35	515	360	2/6
40	680	370	2/8
50	835	485	3/-
75	1250	600	3/4
100	1820	815	3/10
150	2300	960	4/8
200	3100	1870	5/4
250	3750	2200	5/8
300	4500	2300	6/-
400	4950	2500	6/6

Sold by all Wireless Dealers

Sole Manufacturers

The Hawk Coil Co., ST. MARY'S ROAD, SURBITON, SURREY.

AUCTION DAY, Feb. 6

A large Sale
BY AUCTION

comprising
ex-Government & well-known makes
of

**WIRELESS SETS, COMPONENTS
and ACCESSORIES**

will be held on
Friday, February 6th, at 12 o'clock.

Sold in suitable Lots

TO THE TRADE & PUBLIC

On view Thursday, February 5th.

Auctioneers:

**Messrs. OUTHWAITE & LITHERLAND,
49/51, South Castle Street, LIVERPOOL.**

Catalogues on request.

Barclays Ad.

than that the results are poor and distorted. The use of three low-frequency stages coupled by means of many makes of transformers is practically certain to give distortion, and in some cases actually weaker signals, as the result of self-oscillation of the low-frequency valves than would be obtained with only two valves. To use three transformer coupled stages of low-frequency great care is necessary in the design and spacing of your transformers, and it is beyond the scope of the ordinary amateur to make an amplifier of this type work successfully. With regard to the high-frequency side of the set the addition of high-frequency valves to an existing design is often a very unsatisfactory expedient, and although we are not given details as to how it has been carried out in this particular case, we think we are perfectly safe in assuming that it is not possible to do this in a really effective manner. You show the extra H.F. valve with a 70,000 ohm resistance in its anode. Actually if you have done it this way you cannot expect anything except the poorest results, since resistance capacity coupling is only effective on wavelengths above 1,000 metres. It is of little use employing this

method of high-frequency coupling below 1,000 metres.

E. L. (LONDON, N.) wishes to construct a two-H.F. and Detector set using the neutrodyne principle and to reflex both H.F. valves and at the same time use a double condenser for tuning the two high frequency stages. He wishes to know whether the ordinary H.F. plug-in transformer normally used for the 300-600 metre range will be satisfactory in this receiver. The set is to be used for long distance reception and mostly with a frame aerial.

The set as suggested has a number of drawbacks, which are as follows: When tuning two stages of neutrodyne H.F. it has been found in practice that although matched transformers may be used, the condenser readings vary to a much greater extent than would be expected. Hence the use of a double condenser is scarcely satisfactory in this case. If three stages of neutrodyne high-frequency are used, a double condenser may then be used for the first two stages, but the last stage should certainly have a separate condenser. The difficulty may to a certain extent be overcome by placing across the half

of the double condenser which tunes the second H.F. valve a small vernier condenser. This vernier condenser will allow of the variation in tuning being successfully taken up. A two-plate vernier condenser of ordinary type would be quite successful here.

We do not advise trying the effects of reflexing the two H.F. valves, as this introduces considerable complication and does not allow of using these two valves to get the full amount of high-frequency amplification from them. In using the ordinary type of 300-600-metre plug-in transformers in a neutrodyne circuit as suggested, it is found that the minimum instead of being 300 as when used with plain transformer coupling, is raised and is usually somewhere in the region of 350 metres, or higher, according to the number of H.F. stages used. A number of makers are now making a special transformer which is marketed as a neutrodyne unit. These have a lower minimum and are suitable to cover the ordinary broadcast wavelength band, using a .0002 or .0003 μ F variable condenser in parallel with the anode winding. The best type of plug-in transformers to use in a neutrodyne circuit are those having primaries and secondaries wound in separate slots.

It's
THE LEAK
that Counts.

The **Bretwood Grid Leak** (Guaranteed) tunes a carrier wave from the silent point up. The Bretwood is recognised by highest experts and experimenters as the only variable and reliable Grid Leak.

Price 3/-
Postage 3d.
Patent Pending.

The "Leak" with the N.P.L. report. Send for copy.



BRETWOOD PATENT VALVE HOLDER.

Eliminate poor reception by adopting this scientifically designed Valve Holder, and obtain 100 per cent. efficiency. Easy to fix. No capacity. No leakage. Always perfect contact. No soldering. Can be mounted on front or back of Panel.

Price 1/9. Postage 3d

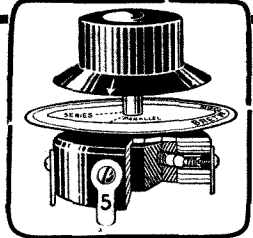
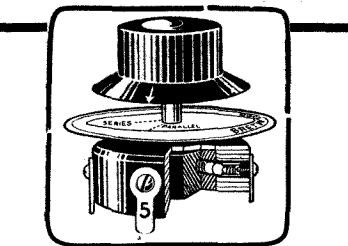
ANTI-CAPACITY SWITCH.

We have pleasure in presenting another first-class speciality, which is the outcome of the famous **BRETWOOD ANTI-CAPACITY VALVE HOLDER**, which has gained such popularity among the wireless public on account of its scientific design and smart appearance. The **Bretwood Switch** is constructed on similar lines, and we claim that it is, like the Valve Holder, absolutely free from capacity effects, and we feel confident that this component will meet with the most exacting requirements of the present day experimenter. One of the principal features of the Bretwood Switch is its beautifully smooth action, made possible by the spring loaded balls, and the wiping or rolling motion of the Phosphor-Bronze Palls always ensures clean and perfect electrical contact.

Features: 1. Absolute freedom from capacity. 2. Perfect contact. 3. Sweet and smooth action. 4. Practically no wear-and-tear. 5. First-class finish and neat in appearance. 6. Easy to fix (one hole fixing). 7. Very easy to make wire connections. 8. Like our other components, it is fully guaranteed. 9. For value offered, the price is moderate.

Price **5/-**
Postage 3d.

RADIO IMPROVEMENTS, LTD.,
12-18, London Mews, Maple St., London, W.

All Bretwood specialities are obtainable from most Wireless Dealers.

Harlie
FOOL-PROOF
DETECTOR

Continuous reception in any position at all times, owing to the special design of both crystal and cats-whisker, is the keynote of this excellent detector.

SOME NOVEL FEATURES—

1. Nickel-plated, detachable, dust-proof, cover.
2. Special "Harlie" super-sensitive crystal.
3. Ebonite wheel for rotating crystal
4. Catswhisker on slider for covering whole surface of crystal.
5. Nickel-plated sockets for panel mounting.



(Provisional Patent 26791/24).
PRICE COMPLETE
5/6

Obtainable from all dealers or direct from
Patentees and Manufacturers.

GENEROUS TRADE TERMS. Telephone—CLISSOLD 293.

HARLIE BROTHERS
183, DALSTON LANE, HACKNEY, LONDON, E.8

Barclays 698

Barclays 689.

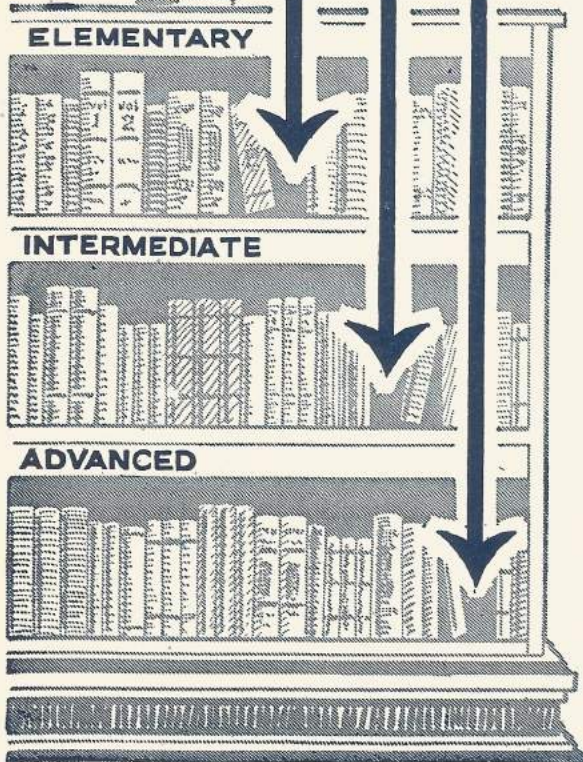

Put it there!

NO matter whether you are a beginner, amateur or expert in matters wireless, you will find one or more books that will be of very great assistance to you among the excellent series published by the Radio Press. It is quite likely that one of those illustrated above is just what you need now.

HOW TO MAKE YOUR OWN BROADCAST RECEIVER.

By John Scott-Taggart, F. Inst. P., A. M. I. E. E.

An ideal book for the beginner, showing how he can build cheaply and well a Broadcast Receiver.

Series No. S3.

1/6 or 1/8 post free.

HOME BUILT WIRELESS COMPONENTS.

Shows how the enthusiast can make for himself every component required for a Receiving Set. It pays for itself in the first few pages.

Series No. S16.

2/6 or 2/8 post free.

WIRELESS SETS FOR HOME CONSTRUCTORS.

By E. Redpath.

A book which instructs its readers how to make efficient Wireless Sets for all purposes.

Series No. S17.

2/6 or 2/8 post free.

Complete List "S" of Radio Press Series of Books will be sent post free on application. Obtainable from all Newsagents, Bookstalls, local Wireless Dealers, or direct from the Publishers. When ordering direct be sure and quote Series No. "S—".

Radio Press, Ltd.
BUSH HOUSE, STRAND, LONDON, W.C.2.



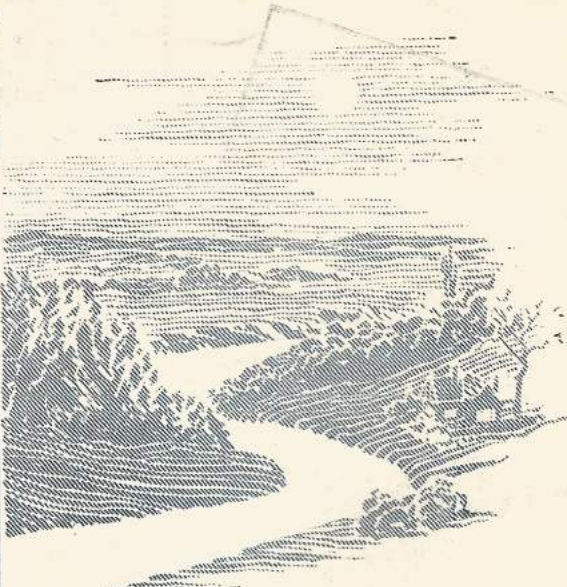

*Here will we sit, and let the sounds of music
Creep in our ears; soft stillness, and the night,
Become the touches of sweet harmony
Shakespeare, Merchant of Venice.*

The New Master of Music

A new factor has entered into music—the Sterling “Primax” Hornless Loud Speaker. For here is a radio instrument truly capable of charming the listener with the sympathy of a voice, the melodic appeal of a piano, and the inspiration of orchestral music. A test at any good radio dealers will confirm the fact that there is no loud speaker that can compare in tone, or volume and purity—the “Primax” is incomparable, supreme.

The Sterling “Primax” Hornless Loud Speaker has a pleated diaphragm mounted in a frame and supported on a graceful stand. The whole instrument is bronzed finish. It is connected to the receiver in exactly the same way as an ordinary loud speaker. Complete with 12 ft. of flexible cord. (2,000 ohms resistance.)

PRICE **£7:15:0**

STERLING PRIMAX

Hornless Loud Speaker (Bronzed Finish)

At your Radio dealers

Advt. of **STERLING TELEPHONE AND ELECTRIC CO., LTD.**

Manufacturers of Telephones and Radio Apparatus, etc.
210-212, TOTTENHAM COURT ROAD, LONDON, W.1

Works: DAGENHAM, ESSEX.

Sole Manufacturers and Licensees of the “Primax” Loud Speaker

